



3M™ Selection Guide

- Incise Drapes
- Surgical Drapes/Packs
- Surgical Gowns
- Custom Packs and Procedure Trays



3M Health Care
Infection Prevention Division
Europe, CEE, MEA
Hammfelddamm 11
41453 Neuss
Germany
Tel: ++49 (0) 2131-14 30 00
Fax: ++49 (0) 2131-14 44 43
www.3m.com/uk/healthcare

Ref.-No. 1328-201-EU – 01/2010
3M, Steri-Drape and loban are trademarks
of the 3M Company. Please recycle.
© 3M 2010. All rights reserved.



3M™ Surgical Drapes Selection Guide

3M™ Drapes: made with materials designed for better infection prevention

3M™ Absorbent Impervious Material is only one of the many features you'll find in our full line of drapes. Our expertise in adhesives, coatings, film and nonwoven technologies allows us to provide the drape features most important to surgical teams.

From our breathable, nonwoven "fabric" drapes to our antimicrobial incise drapes and everything in between, you'll find a 3M™ drape with features you need to help create the sterile environment necessary for positive patient outcomes.



Nonwoven Fabric

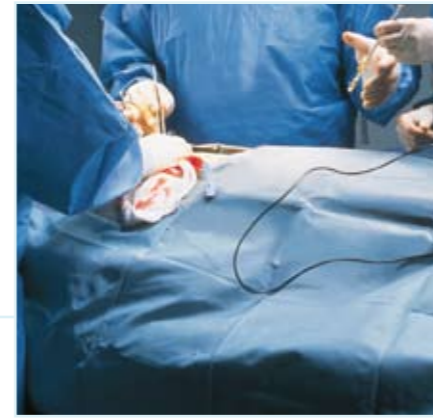

Absorbent Impervious Material

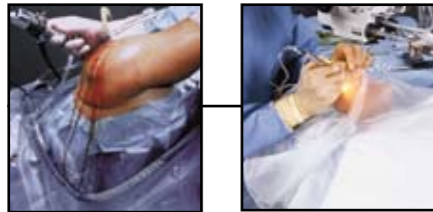

Patient Fluid Control

Clear Polyethylene Film

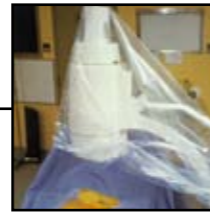

Equipment



Clear Incise Film

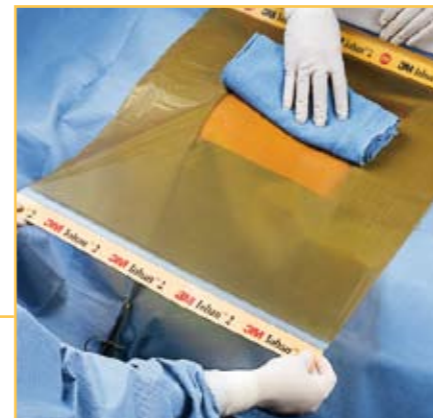

Antimicrobial Incise Film

The 3M™ Surgical Drape range ...

From the leader in Medical Adhesive and Drape Materials

Surgeons all over the world rely on 3M for many of their draping needs. 3M has made use of innovative technologies to create a highly advanced range of single-use surgical drapes, for the highest level of performance and reliability.

Cost Savings

The 3M surgical drape range consists of both specialized packs and individual drapes for cost effective and flexible draping solutions.

Customer Support

3M provides a high-quality and dependable level of service to thousands of health care workers each day. This means offering all the support possible to help meet the fast changing demands of today's surgical procedures.



3M Environmental Care

3M has an approach to the environment based on prevention at source. The company believes that it is better to prevent pollution rather than remove it after it has been created. This concept means applying more intelligence to produce high-value products with fewer resources and fewer environmental impacts.

The 3M Environmental Policy involves:

- Preventing pollution at source, whenever possible.
- Developing products that have a minimum effect on the environment.
- Conserving natural resources through reclamation and other appropriate methods.
- Meeting and sustaining government regulations.
- Participating in Government-led environmental initiatives, wherever possible.

... the role of Surgical Drapes

Surgical Drapes are designed to establish and maintain a sterile field. It is very important to select a surgical drape that provides reliable performance. To achieve the best surgical outcomes, look for surgical drapes with these qualities:

Impervious to Strikethrough

A drape that allows fluid strikethrough, and thus bacteria transfer, compromises the sterile field, which increases the risk of Surgical Site Infection. That is why a drape that is impervious to liquid is so important.



Fluid Control Features

3M surgical drapes effectively control and contain fluid. The absorbent top layer soaks up spills and splatters, keeping fluid off the drape surface while the film part of the material maintains an impervious barrier. Many 3M surgical drapes have fluid collection pouches, which channel and collect body and irrigation fluids.

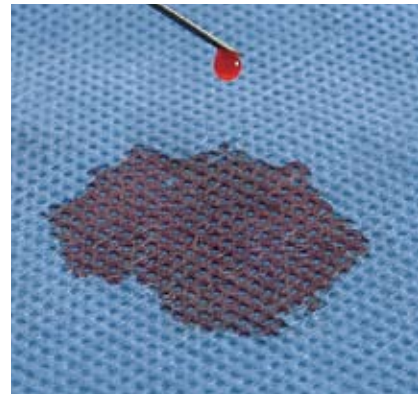

Reliable Adhesion

3M is a leader in adhesive technology, and has applied this expertise to provide surgical drapes with consistently reliable adhesion to the skin or wound edge. 3M incise drapes adhere securely to wound edges, even during heavy retraction and irrigation, providing a barrier to bacteria on the skin.



Superior Strength and Comfort

The material of the Steri-Drape range of surgical drapes is strong enough to withstand the most arduous procedures and manipulation. They are soft and pliable for easy application.

3M Range

3M surgical drapes are available individually and in specialised packs to cover most surgical procedures. The contents of each draping pack are tailored to match the requirements of each and every procedure. Fully customised packs are also available, to save time and minimise waste.



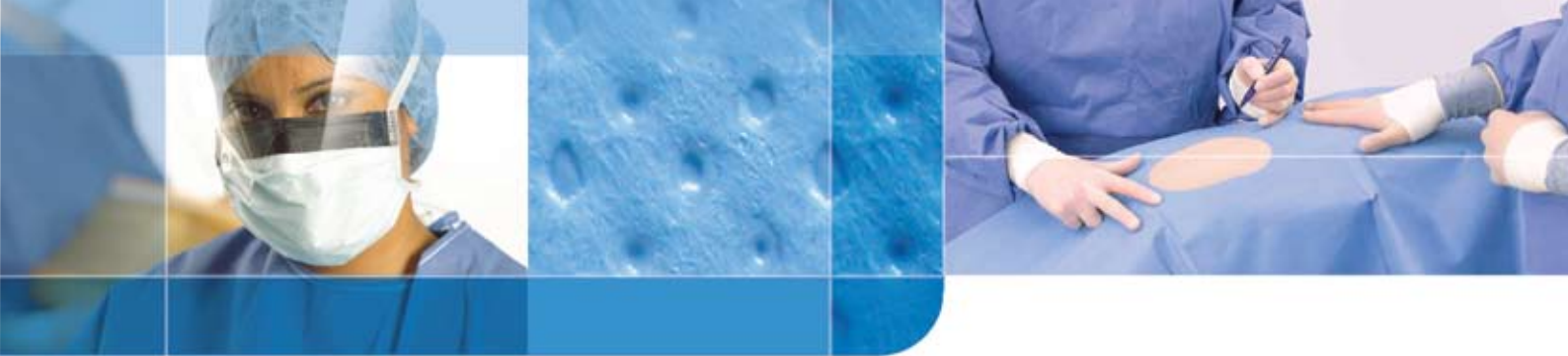

Defining the Critical Zone

A drape's critical zone is defined as the area where direct contact with blood, bodily fluids and other potentially infectious material can occur. Although the area immediately surrounding the incision site has generally been referred to as the critical zone, the two are not necessarily synonymous. In a survey in 2003, 72% of surgeons said that fluids get outside the traditional critical zone¹.

Irrigation fluids used in many of today's procedures, and the placing of wet swabs on the patient drape can cause strike-through and compromise sterility. The traditional perception of a defined area of the drape representing the critical zone does not fit the definition. Today's critical zone must consider the entire sterile field to ensure optimum infection prevention.

3M Drapes Designed for the Entire Critical Zone

- 3M Health Care understands that the risk of infection increases when strike-through occurs anywhere within the sterile field, not just in the traditional critical zone.
- Many of our drapes feature an absorbent, impervious material throughout the drape to incorporate the true critical zone... the entire sterile field.

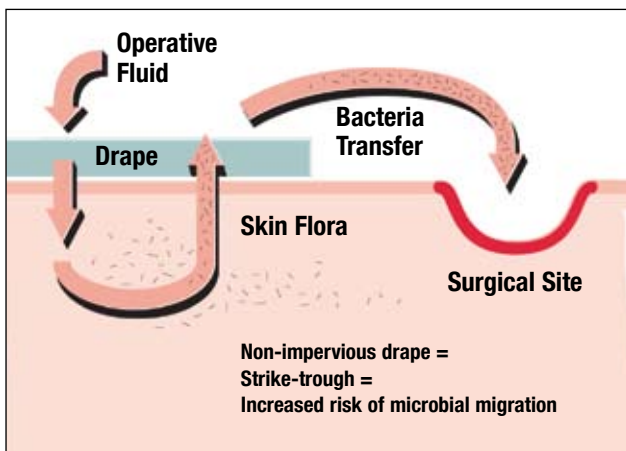

A drape that allows fluid transfer, and therefore transfer of bacteria, compromises the sterile field and increases the risk of surgical site infection.

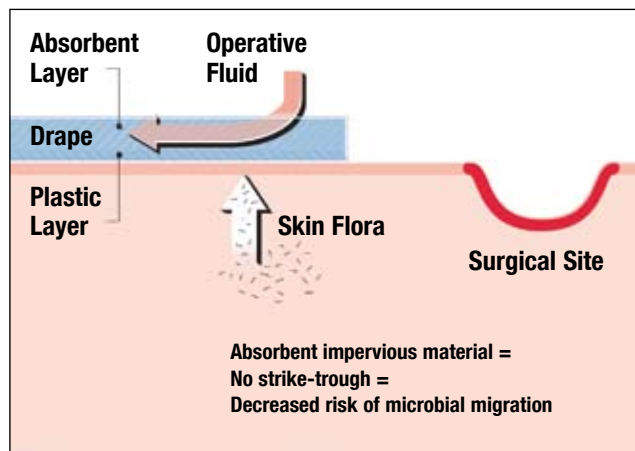

Creating a true barrier with a drape that is impervious to strike-through is imperative.

¹AAOS attendee survey, Feb. 2003. 3M data on file.

Selection Guide

Incise Drapes	10 - 14
3M™ Ioban™ 2 Antimicrobial Incise Drapes	11
3M™ Ioban™ EZ Antimicrobial Incise Drapes	12
3M™ Steri-Drape™ 2 Incise Drapes	13
3M™ Steri-Drape™ Incise Drapes	14
General Surgery Drapes / Packs	16 - 26
Orthopaedic Drapes / Packs	28 - 36
Cardiovascular and Cardiac Catheterisation Drapes / Packs	38 - 41
Obstetrics and Gynaecology Drapes / Packs	44 - 52
Urology Drapes / Packs	54 - 60
Ophthalmic Drapes / Packs	62 - 66
Head and Neck Drapes / Packs	68 - 70
Neurosurgery Drapes / Packs	72 - 74
Other Drapes and Accessories	76 - 86
Single Use Surgical Gowns Standard and Reinforced	88 - 91
3M™ High Protection Surgical Gowns – Regular, Standard and Reinforced	89
3M™ Comfort Surgical Gowns – Standard and Reinforced	90
3M™ Basic Surgical Gowns – Standard and Standard T	91
Custom Packs and Procedure Trays	94
Cross Reference by Product Number	96 - 98
Cross Reference by Product Name	100 - 103

Incise Drapes

General Surgery Drapes / Packs

Orthopaedic Drapes / Packs

Cardiovascular and Cardiac Catheterisation Drapes / Packs

Obstetrics and Gynaecology Drapes / Packs

Urology Drapes / Packs

Ophthalmic Drapes / Packs

Head and Neck Drapes / Packs

Neurosurgery Drapes / Packs

Other drapes and accessories

Single Use Gowns – Standard and Reinforced

Custom Packs and Procedure Trays

Cross Reference by Product Number

Cross Reference by Product Name



Incise Drapes

Research has shown a percentage of the patient population naturally hosts larger numbers of skin bacteria than others.² Even after prepping it is difficult to establish how many bacteria remain on the skin.

The chance of a surgical site infection occurring can be reduced using a combination of pre-operative skin prep products and incise drapes.

3M has a range of incise drapes that can help reduce the likelihood of skin recolonisation after prepping and thus reduce the risk of surgical site infections.

3M™ Ioban™ 2 Antimicrobial Film Incise Drapes

- Contains iodophor in the adhesive and provide continuous broad-spectrum antimicrobial activity from the time of incision to wound closure.
- Have a high moisture vapour transmission rate which allows the skin to “breathe” ensuring improved adhesion throughout the longest procedures.
- Are highly conformable to body contours. The unique low memory stretch allows limb mobilisation or heavy retraction with reduced tension to the skin.
- Have superb adhesion right up to the wound edge.

3M™ Ioban™ EZ Antimicrobial Incise Drapes

In addition, the Ioban EZ incise drape is also available which includes the “easy-delivery” drape application feature (except 6635), including a removable cardboard strip.

3M™ Steri-Drape™ 2 Incise Drapes

- Are made of a breathable film which provides superior adhesion.
- Have low memory stretch.
- Conform to body contours and stretch to allow limb manipulation.

3M™ Steri-Drape™ Incise Drapes

- Are the original incise drapes which have a pressure sensitive adhesive.

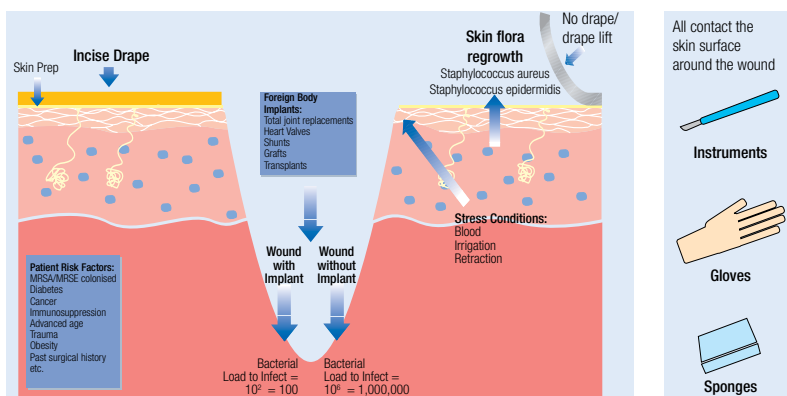

Dougherty, Steve H. "Pathobiology of Infection in Prosthetic Devices." Reviews of Infectious Diseases 10:5 (Nov.-Dec. 1988). p.1102.



² Data on file. 3M Health Care Ltd.

3M™ Ioban™ 2 Antimicrobial Incise Drapes

15 x 20



6635 Antimicrobial Incise Drape

Overall Size	Incise Area	Drapes per Box	Boxes per Case
15 cm x 20 cm	10 cm x 20 cm	10	4

44 x 35

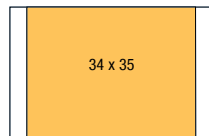

6640 Antimicrobial Incise Drape

Overall Size	Incise Area	Drapes per Box	Boxes per Case
44 cm x 35 cm	34 cm x 35 cm	10	4

66 x 60

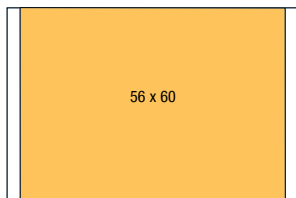

6648 Antimicrobial Incise Drape

Overall Size	Incise Area	Drapes per Box	Boxes per Case
66 cm x 60 cm	56 cm x 60 cm	10	4

66 x 45

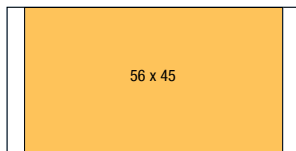

6650 Antimicrobial Incise Drape

Overall Size	Incise Area	Drapes per Box	Boxes per Case
66 cm x 45 cm	56 cm x 45 cm	10	4

66 x 85

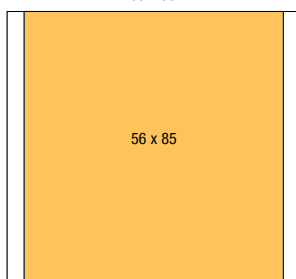

6651 Antimicrobial Incise Drape

Overall Size	Incise Area	Drapes per Box	Boxes per Case
66 cm x 85 cm	56 cm x 85 cm	10	4

KEY	Repellent Fabric	Blue Polyethylene Film	Clear Polyethylene Film	Absorbent Impervious Fabric
	Extra Absorbent Material	3M™ Ioban™ Antimicrobial Incise Film	3M™ Steri-Drape™ Incise Film	Clear Elastomeric Film
	Adhesive Area	Blue Elastomeric Film	Dimensions are approximate	

3M™ Ioban™ EZ Antimicrobial Incise Drapes

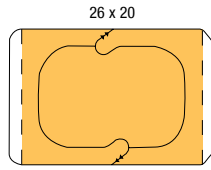

6661EZ Framed 3M™ Ioban™ 2 Incise Drape

Overall Size	Incise Area	Drapes per Box	Boxes per Case
30 cm x 20 cm	26 cm x 20 cm	50	2

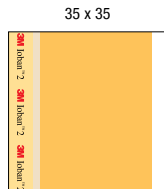

6640EZ Antimicrobial Incise Drape

Overall Size	Incise Area	Drapes per Box	Boxes per Case
60 cm x 35 cm	35 cm x 35 cm	10	4

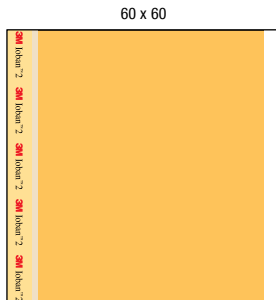

6648EZ Antimicrobial Incise Drape

Overall Size	Incise Area	Drapes per Box	Boxes per Case
90 cm x 60 cm	60 cm x 60 cm	10	4

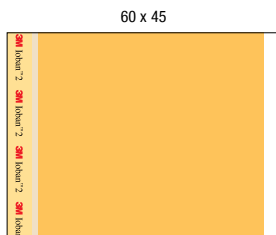

6650EZ Antimicrobial Incise Drape

Overall Size	Incise Area	Drapes per Box	Boxes per Case
90 cm x 45 cm	60 cm x 45 cm	10	4

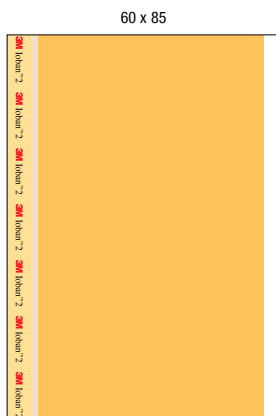

6651EZ Antimicrobial Incise Drape

Overall Size	Incise Area	Drapes per Box	Boxes per Case
90 cm x 85 cm	60 cm x 85 cm	10	4

3M™ Steri-Drape™ 2 Incise Drapes

20 x 20



2035 Incise Drape

Overall Size	Incise Area	Drapes per Box	Boxes per Case
20 cm x 20 cm	10 cm x 20 cm	10	4

38 x 25



2037 Incise Drape

Overall Size	Incise Area	Drapes per Box	Boxes per Case
38 cm x 25 cm	28 cm x 25 cm	10	4

38 x 41

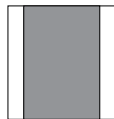

2040 Incise Drape

Overall Size	Incise Area	Drapes per Box	Boxes per Case
38 cm x 41 cm	28 cm x 41 cm	10	4

60 x 45



2045 Incise Drape

Overall Size	Incise Area	Drapes per Box	Boxes per Case
60 cm x 45 cm	50 cm x 45 cm	10	4

90 x 60

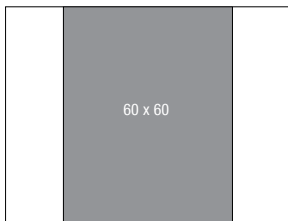

2050 Incise Drape

Overall Size	Incise Area	Drapes per Box	Boxes per Case
90 cm x 60 cm	60 cm x 60 cm	10	4

90 x 85

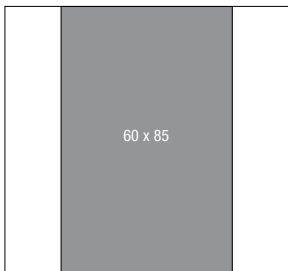

2051 Incise Drape

Overall Size	Incise Area	Drapes per Box	Boxes per Case
90 cm x 85 cm	60 cm x 85 cm	10	4

KEY	Repellent Fabric	Blue Polyethylene Film	Clear Polyethylene Film	Absorbent Impervious Fabric
	Extra Absorbent Material	3M™ Ioban™ Antimicrobial Incise Film	3M™ Steri-Drape™ Incise Film	Clear Elastomeric Film
	Adhesive Area	Blue Elastomeric Film	Dimensions are approximate	

3M™ Steri-Drape™ 2 Incise Drapes

15 x 20



1035 Incise Drape

Overall Size	Incise Area	Drapes per Box	Boxes per Case
15 cm x 20 cm	10 cm x 20 cm	10	4

29 x 25



1037 Incise Drape

Overall Size	Incise Area	Drapes per Box	Boxes per Case
29 cm x 25 cm	19 cm x 25 cm	10	4

60 x 35

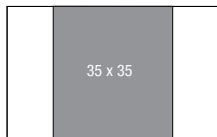

1040 Incise Drape

Overall Size	Incise Area	Drapes per Box	Boxes per Case
60 cm x 35 cm	35 cm x 35 cm	10	4

82 x 45

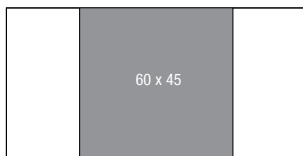

1050 Incise Drape

Overall Size	Incise Area	Drapes per Box	Boxes per Case
82 cm x 45 cm	60 cm x 45 cm	10	4

82 x 85

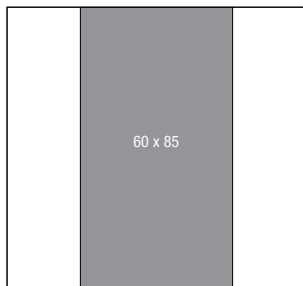

1051 Incise Drape

Overall Size	Incise Area	Drapes per Box	Boxes per Case
82 cm x 85 cm	60 cm x 85 cm	10	4

Incise Drapes

General Surgery Drapes / Packs

Orthopaedic Drapes / Packs

Cardiovascular and Cardiac Catheterisation Drapes / Packs

Obstetrics and Gynaecology Drapes / Packs

Urology Drapes / Packs

Ophthalmic Drapes / Packs

Head and Neck Drapes / Packs

Neurosurgery Drapes / Packs

Other Drapes and Accessories

Single Use Gowns – Standard and Reinforced

Custom Packs and Procedure Trays

Cross Reference by Product Number

Cross Reference by Product Name

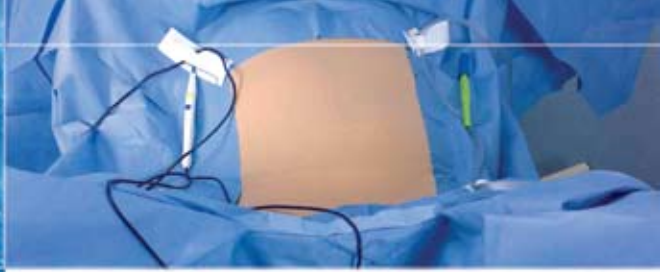
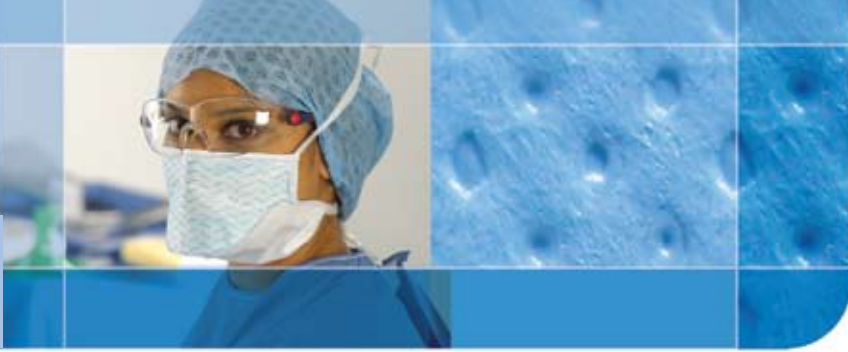

General Surgery

As general surgery procedures vary so much the drapes used need to be adaptable and cater for the challenges likely to be met, such as large volumes of blood and irrigation fluids, heavy retraction during major abdominal procedures and procedures that may last for several hours.

Impervious to Strikethrough

A drape that allows fluid strikethrough, and thus bacteria transfer, compromises the sterile field, which increases the risk of Surgical Site Infection. That is why a drape that is impervious to liquid is so important.

Fluid Control Features

3M surgical drapes effectively control and contain fluid. The absorbent top layer soaks up spills and splatters, keeping fluid off the drape surface while the film part of the material maintains an impervious barrier. Many 3M surgical drapes have fluid collection pouches, which channel and collect body and irrigation fluids.

Superior Strength and Comfort

The material of the Steri-Drape range of surgical drapes is strong enough to withstand the most arduous procedures and manipulation. They are soft and pliable for easy application.

Reliable Adhesion

3M is a leader in adhesive technology, and has applied this expertise to provide surgical drapes with consistently reliable adhesion to the skin or wound edge. 3M incise drapes adhere securely to wound edges, even during heavy retraction and irrigation, providing a barrier to bacteria on the skin.

3M™ loban™ 2 Antimicrobial Incise Drapes

loban 2 antimicrobial incise drapes contain iodophor in the adhesive which is slowly released onto the skin surface giving continuous and controlled antimicrobial activity throughout the surgical procedure. An loban incise area is featured in some speciality drapes. loban incise drapes are also available as separate items.



General Surgery Drapes / Packs

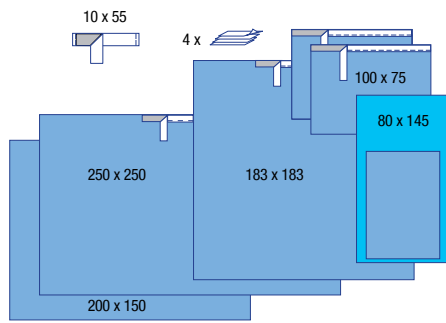

9000 Basic Surgical Pack

Product	Quantity	Overall Size	Packs per Box	Boxes per Case
Operation Tape	1	10 cm x 55 cm	7	2
Hand Towels	4	–		
Mayo Stand Cover	1	80 cm x 145 cm		
Adhesive Towel Drapes	2	100 cm x 75 cm		
Adhesive Drape Sheet (M)	1	183 cm x 183 cm		
Adhesive Drape Sheet (L)	1	250 cm x 150 cm		
Instrument Table Cover	1	200 cm x 150 cm		

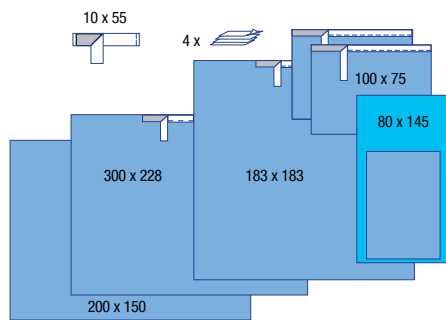

9000L Basic Surgical Pack

Product	Quantity	Overall Size	Packs per Box	Boxes per Case
Operation Tape	1	10 cm x 55 cm	5	2
Hand Towels	4	–		
Mayo Stand Cover	1	80 cm x 145 cm		
Adhesive Towel Drapes	2	100 cm x 75 cm		
Adhesive Drape Sheet (M)	1	183 cm x 183 cm		
Adhesive Drape Sheet (XL)	1	300 cm x 228 cm		
Instrument Table Cover	1	200 cm x 150 cm		

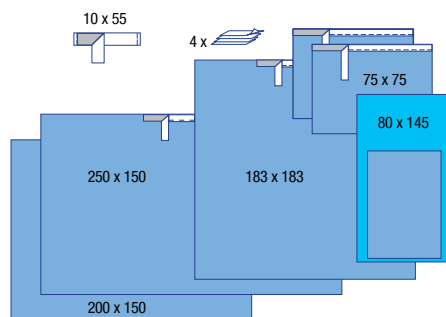

9001 Paediatric Pack

Product	Quantity	Overall Size	Packs per Box	Boxes per Case
Operation Tape	1	10 cm x 55 cm	7	2
Hand Towels	4	–		
Mayo Stand Cover	1	80 cm x 145 cm		
Adhesive Towel Drapes	2	75 cm x 75 cm		
Adhesive Drape Sheet (M)	1	183 cm x 183 cm		
Adhesive Drape Sheet (L)	1	250 cm x 150 cm		
Instrument Table Cover	1	200 cm x 150 cm		
Narrow Adhesive Strip (2.5 cm)				

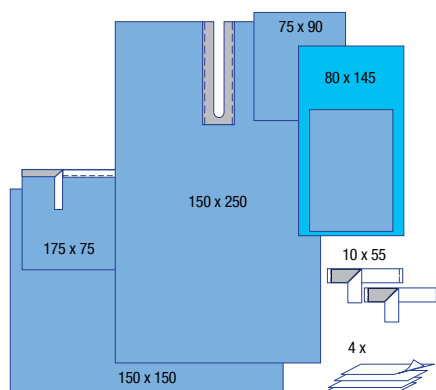

9007 ENT Surgical Pack

Product	Quantity	Overall Size	Packs per Box	Boxes per Case
Operation Tape	2	10 cm x 55 cm	8	2
Hand Towels	4	–		
Mayo Stand Cover	1	80 cm x 145 cm		
Drape Sheet	1	75 cm x 90 cm		
Adhesive Split Sheet	1	150 cm x 250 cm		
Adhesive Towel Drape	1	100 cm x 75 cm		
Instrument Table Cover	1	150 cm x 150 cm		

KEY	Repellent Fabric	Blue Polyethylene Film
	Extra Absorbent Material	3M™ Ioban™ Antimicrobial Incise Film
	Adhesive Area	Blue Elastomeric Film

Clear Polyethylene Film	Absorbent Impervious Fabric
3M™ Steri-Drape™ Incise Film	Clear Elastomeric Film

Dimensions are approximate

General Surgery Drapes / Packs

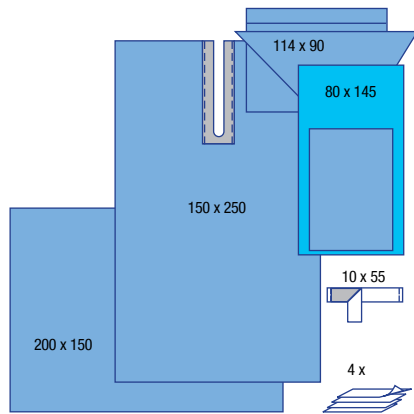

9008 Head and Neck Pack

Product	Quantity	Overall Size	Packs per Box	Boxes per Case
Operation Tape	1	10 cm x 55 cm	7	2
Hand Towels	4	–		
Mayo Stand Cover	1	80 cm x 145 cm		
Headwrap	1	114 cm x 90 cm		
Adhesive Split Sheet	1	150 cm x 250 cm		
Instrument Table Cover	1	250 cm x 150 cm		

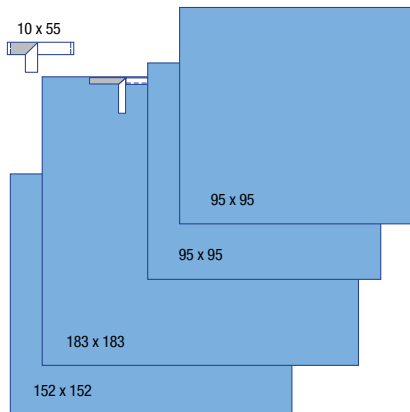

9009 Basic Head and Neck Pack

Product	Quantity	Overall Size	Packs per Box	Boxes per Case
Operation Tape	1	10 cm x 55 cm	10	2
Non Adhesive Drape Sheet	2	95 cm x 95 cm		
Adhesive Drape Sheet	1	183 cm x 183 cm		
Back Table Cover	1	152 cm x 152 cm		

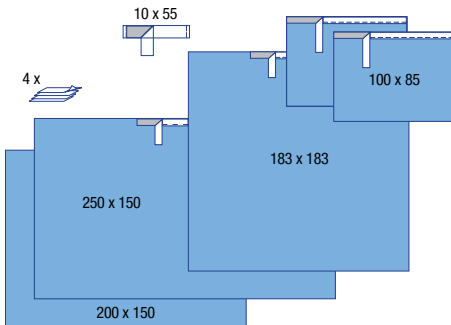

9010 Basic Surgical Pack without Mayo

Product	Quantity	Overall Size	Packs per Box	Boxes per Case
Operation Tape	1	10 cm x 55 cm	7	2
Hand Towels	4	–		
Adhesive Towel Drapes	2	100 cm x 85 cm		
Adhesive Drape Sheet (M)	1	183 cm x 183 cm		
Adhesive Drape Sheet (L)	1	250 cm x 150 cm		
Instrument Table Cover	1	250 cm x 150 cm		

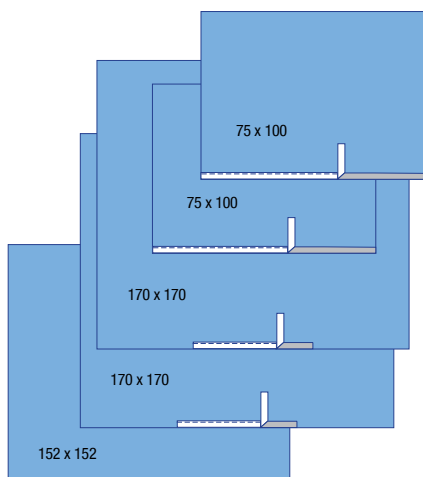

9100 General Pack

Product	Quantity	Overall Size	Packs per Box	Boxes per Case
Adhesive Side Towel	2	100 cm x 75 cm	7	2
Adhesive Drape Sheet	2	170 cm x 170 cm		
Back Table Cover	1	152 cm x 152 cm		

General Surgery Drapes / Packs

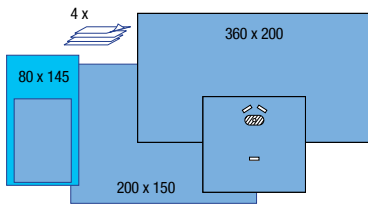

9015 Hand Pack

Product	Quantity	Overall Size	Packs per Box	Boxes per Case
Operation Tape	1	10 cm x 55 cm	7	2
Hand Towels	4	–		
Mayo Stand Cover	1	80 cm x 145 cm		
Adhesive Towel Drapes	2	100 cm x 75 cm		
Adhesive Drape Sheet (M)	1	183 cm x 183 cm		
Adhesive Drape Sheet (L)	1	250 cm x 150 cm		
Instrument Table Cover	1	200 cm x 150 cm		

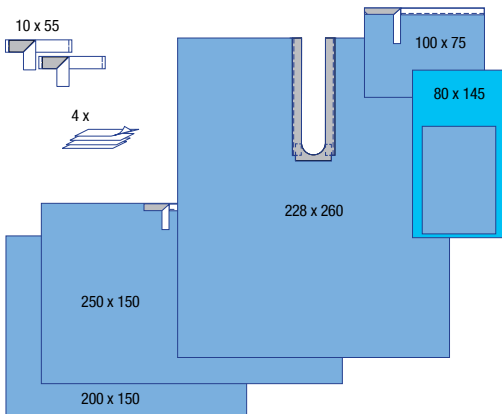

9018 Surgical Split Sheet Pack

Product	Quantity	Overall Size	Packs per Box	Boxes per Case
Operation Tapes	2	10 cm x 55 cm	6	2
Hand Towels	4	–		
Mayo Stand Cover	1	80 cm x 145 cm		
Adhesive Towel Drape	2	100 cm x 75 cm		
Adhesive Split Sheet	1	228 cm x 260 cm		
Adhesive Drape Sheet (L)	1	250 cm x 150 cm		
Instrument Table Cover	1	200 cm x 150 cm		

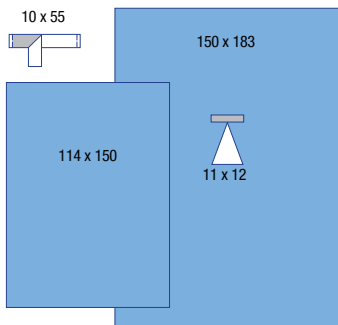

9019 Oral Pack

Product	Quantity	Overall Size	Packs per Box	Boxes per Case
Operation Tape	1	10 cm x 15 cm	16	2
Adhesive Aperture Drape	1	150 cm x 183 cm		
Non Adhesive Drape Sheet	1	114 cm x 150 cm		

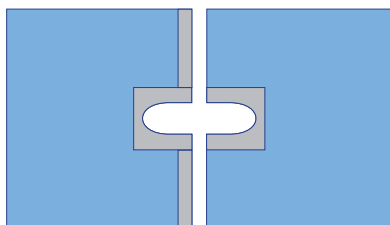

9027 Adjustable Aperture Drape

Product	Quantity	Overall Size	Packs per Box	Boxes per Case
Two piece Adjustable Aperture Drape	1	70 cm x 50 cm	40	4

9027L Adjustable Aperture Drape (Long)

Product	Quantity	Overall Size	Packs per Box	Boxes per Case
Two piece Adjustable Aperture Drape	1	100 cm x 150 cm	25	4

- KEY**
- Repellent Fabric
 - Blue Polyethylene Film
 - Clear Polyethylene Film
 - Absorbent Impervious Fabric
 - Extra Absorbent Material
 - 3M™ Ioban™ Antimicrobial Incise Film
 - 3M™ Steri-Drape™ Incise Film
 - Clear Elastomeric Film
 - Adhesive Area
 - Blue Elastomeric Film

Dimensions are approximate

General Surgery Drapes / Packs

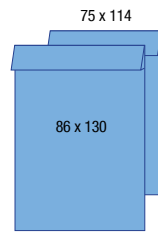

9040 Leggings (pair)

Overall Size	Drapes per Box	Boxes per Case
75 cm x 114 cm	12	4

9040L Leggings Long (pair)

Overall Size	Drapes per Box	Boxes per Case
86 cm x 130 cm	8	4

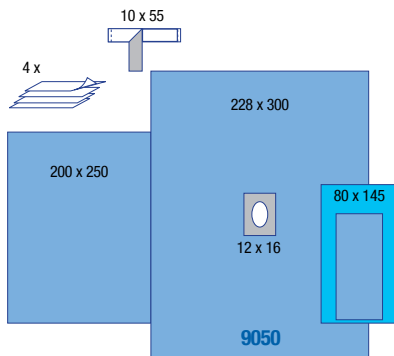

9050 Adhesive Aperture Drape

Overall Size	Adhesive Aperture Size	Drapes per Box	Boxes per Case
228 cm x 12 cm	12 cm x 16 cm	10	2

9050P General Surgery Pack

Product	Quantity	Adhesive Aperture Size	Overall Size	Packs per Box	Boxes per Case
Operation Tape	1		10 cm x 55 cm	7	2
Hand Towels	4		–		
Mayo Stand Cover	1		80 cm x 145 cm		
Adhesive Aperture Drape	1	12 x 16 cm	228 cm x 300 cm		
Instrument Table Cover	1		200 cm x 150 cm		

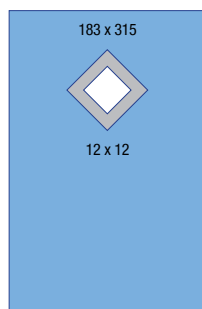

9051 Thyroid Drape

Overall Size	Adhesive Aperture Size	Drapes per Box	Boxes per Case
183 cm x 315 cm	12 cm x 12 cm	15	2

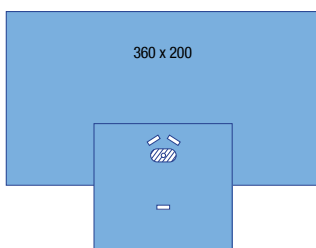

9052 Hand Drape

Overall Size	Aperture Size	Drapes per Box	Boxes per Case
360 cm x 200 cm	3 cm	9	2

General Surgery Drapes / Packs

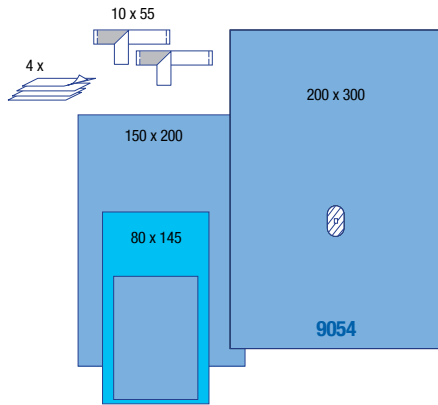

9054 Foot / Hand Drape

Overall Size	Aperture Size	Drapes per Box	Boxes per Case
200 cm x 300 cm	3 cm	12	2

9054P Foot / Hand Pack

Product	Quantity	Overall Size	Packs per Box	Boxes per Case
Operation Tapes	2	10 cm x 55 cm	7	2
Hand Towels	4	–		
Mayo Stand Cover	1	80 cm x 145 cm		
Food/Hand Drape	1	200 cm x 300 cm		
Instrument Table Cover	1	150 cm x 200 cm		

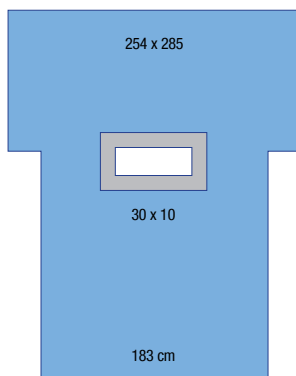

9062 Laparotomy Drape (Transverse)

Overall Size	Adhesive Aperture Size	Drapes per Box	Boxes per Case
254 cm x 285 cm	30 cm x 10 cm	12	2

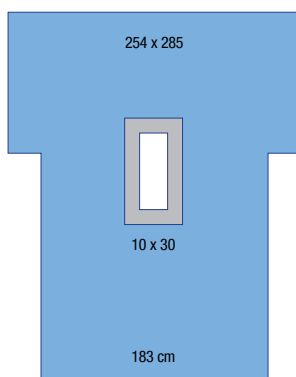

9063 Laparotomy Drape

Overall Size	Adhesive Aperture Size	Drapes per Box	Boxes per Case
254 cm x 285 cm	10 cm x 30 cm	10	2

KEY	Repellent Fabric	Blue Polyethylene Film	Clear Polyethylene Film	Absorbent Impervious Fabric
	Extra Absorbent Material	3M™ Ioban™ Antimicrobial Incise Film	3M™ Steri-Drape™ Incise Film	Clear Elastomeric Film
	Adhesive Area	Blue Elastomeric Film	Dimensions are approximate	

General Surgery Drapes / Packs

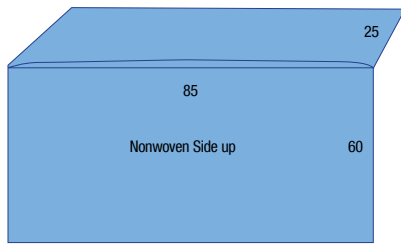

9066 Under Buttock Drape with Cuff

Overall Size	Drapes per Box	Boxes per Case
85 cm x 85 cm	30	4

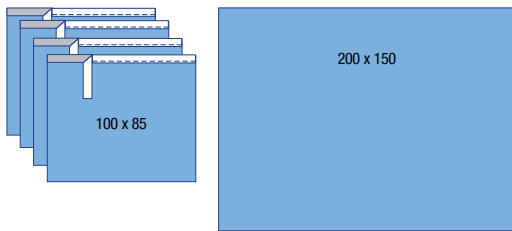

9085P Surgical Towel Pack

Product	Quantity	Overall Size	Packs per Box	Boxes per Case
Adhesive Towel Drape	4	100 cm x 85 cm	11	2
Instrument Table Cover	1	200 cm x 150 cm		

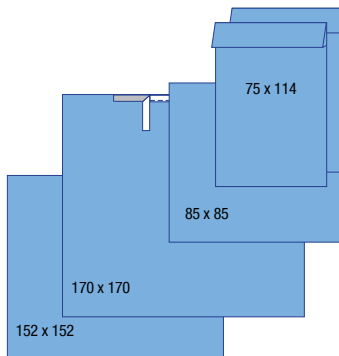

9105 Lithotomy Pack – Under Buttock

Product	Quantity	Overall Size	Packs per Box	Boxes per Case
Under Buttocks Drape with Cuff	1	85 cm x 85 cm	7	2
Leggings	2	75 cm x 114 cm		
Adhesive Drape Sheet	1	170 cm x 170 cm		
Back Table Cover	1	152 cm x 152 cm		

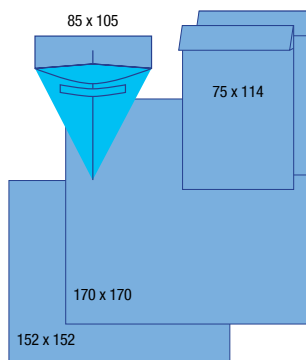

9106 Lithotomy Pack – with Pouch

Product	Quantity	Overall Size	Packs per Box	Boxes per Case
Under Buttocks Drape with Pouch	1	85 cm x 105 cm	7	2
Leggings	2	75 cm x 114 cm		
Adhesive Drape Sheet	1	170 cm x 170 cm		
Back Table Cover	1	152 cm x 152 cm		

General Surgery Drapes / Packs

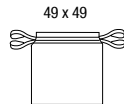

1003 Isolation Bag

Overall Size	Units per Box	Boxes per Case
49 cm x 49 cm	10	4

- Drawstring Closure
- Clear Plastic

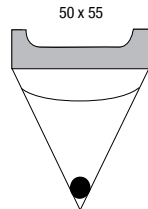

1016 Irrigation Pouch

Overall Size	Units per Box	Boxes per Case
50 cm x 55 cm	10	4

- Adhesive Strip
- 1 Exit Port

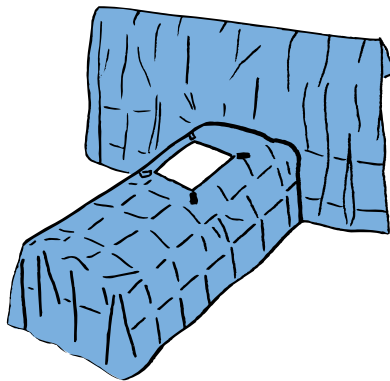

1031 Laparoscopic Drapes - Supine Position

Overall Size	Adhesive Aperture Size	Drapes per Box	Boxes per Case
285 cm x 182 cm	27 cm x 30 cm	10	2

- 4 Tube Organisers (ref. 1115)
- Available as a single box

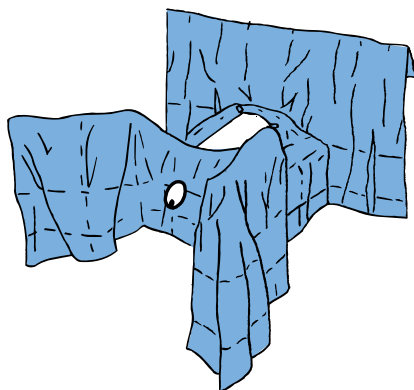

1032 Laparoscopic Drapes - Lithotomy Position

Overall Size	Adhesive Aperture Size	Drapes per Box	Boxes per Case
241 cm x 228 cm	27 cm x 30 cm	8	2

- 4 Tube Organisers (ref. 1115)
- Perineal Adhesive Aperture: 12 cm x 15.5 cm
- Available as a single box

1032P Laparoscopic Drapes Pack / Lithotomy Position

Product	Quantity	Overall Size	Packs per Box	Boxes per Case
Laparoscopy Drape	1	241 cm x 228 cm	5	2
Instrument Table Cover		200 cm x 150 cm		
Hand Towels	4	–		
Mayo Stand Cover	1	80 cm x 145 cm		

- KEY**
- Repellent Fabric
 - Blue Polyethylene Film
 - Clear Polyethylene Film
 - Absorbent Impervious Fabric
 - Extra Absorbent Material
 - 3M™ Ioban™ Antimicrobial Incise Film
 - 3M™ Steri-Drape™ Incise Film
 - Blue Elastomeric Film
 - Adhesive Area
 - Clear Elastomeric Film

Dimensions are approximate

General Surgery Drapes / Packs

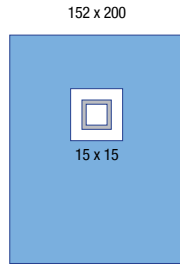

1034 CVC Drape

Overall Size	Drapes per Box	Boxes per Case
152 cm x 200 cm	22	2

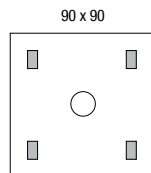

Wound Edge Protector

	Overall Size	Ring Diameter	Drapes per Box	Boxes per Case
1073	90 cm x 90 cm	12.5 cm	10	4
1074	90 cm x 90 cm	17.5 cm	10	4
1075	90 cm x 90 cm	22.5 cm	10	4
1076	90 cm x 90 cm	27.5 cm	10	4
1077	90 cm x 90 cm	9.5 cm	10	4

- 4 Adhesive Patches
- 1 Flexible Ring

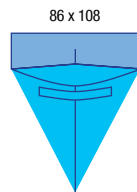

1084 Under Buttocks Drape with Pouch

Overall Size	Drapes per Box	Boxes per Case
86 cm x 108 cm	30	4

- Fluid Collection Pouch

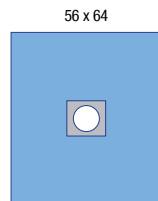

1092 Minor Procedure Drape

Overall Size	Adhesive Aperture Size	Drapes per Box	Boxes per Case
56 cm x 64 cm	6.3 cm	25	4

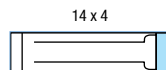

1115 Tube Organiser

Overall Size	Units per Box	Boxes per Case
14 cm x 4 cm	100	4

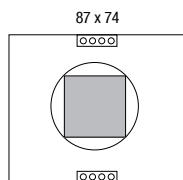

2057 Incise Pouch

Overall Size	3M™ Steri-Drape™ 2 Incise Area	Drape per Box	Boxes per Case
87 cm x 74 cm	30 cm x 30 cm	10	4

- 360-Degree Fluid Collection Pouch
- Tube Organisers

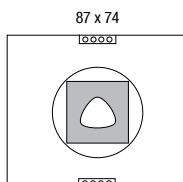

2058 Aperture Pouch

Overall Size	3M™ Steri-Drape™ 2 Incise Area	Drape per Box	Boxes per Case
87 cm x 74 cm	30 cm x 30 cm	10	4

- 360-Degree Fluid Collection Pouch
- Tube Organisers

General Surgery Drapes / Packs

2065 3M™ Abdomino-Perineal Drape-Lithotomy Position

Overall Size	Adhesive Aperture Size	Drapes per Box	Boxes per Case
195 cm x 271 cm	41 cm x 45 cm	8	2

- Tube Organisers
- Perineal Adhesive Aperture: 12 cm x 15.5 cm

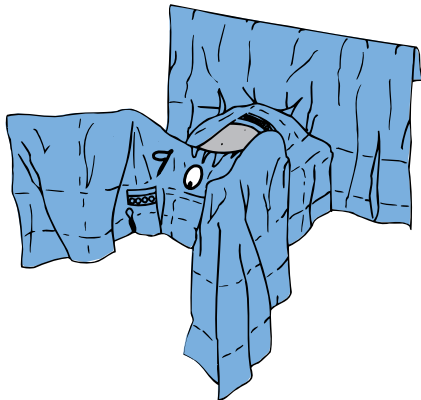

2065P Abdomino-Perineal Draping Pack

Product	Quantity	Overall Size	Packs per Box	Boxes per Case
Abdomino-Perineal Drape	1	195 cm x 271 cm	5	2
Instrument Table Cover	1	100 cm x 150 cm		
Mayo Stand Cover	1	80 cm x 145 cm		
Towel Drape	1	75 cm x 90 cm		
Hand Towels	4	–		

6657 Pouch with 3M™ Ioban™ 2 Incise Film

Overall Size	Ioban 2 incise area	Drape per Box	Boxes per Case
87 cm x 74 cm	30 cm x 30 cm	10	4

- 360-Degree Fluid Collection Pouch
- Tube Organisers

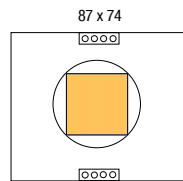

6658 Large Pouch with 3M™ Ioban™ 2 Incise Film

Overall Size	Ioban 2 incise area	Drape per Box	Boxes per Case
74 cm x 74 cm	33 cm x 43 cm	5	4

- Fluid Collection Pouch

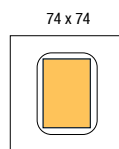

6659 Extra Large Pouch with 3M™ Ioban™ 2 Incise Film

Overall Size	Ioban 2 incise area	Drape per Box	Boxes per Case
74 cm x 87 cm	42 cm x 52 cm	5	4

- 2 Exit Ports

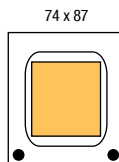

KEY	Repellent Fabric	Blue Polyethylene Film	Clear Polyethylene Film	Absorbent Impervious Fabric
	Extra Absorbent Material	3M™ Ioban™ Antimicrobial Incise Film	3M™ Steri-Drape™ Incise Film	Clear Elastomeric Film
	Adhesive Area	Blue Elastomeric Film		

Dimensions are approximate

General Surgery Drapes / Packs

6665 3M™ Ioban™ 2 Abdomino-Perineal Drape - Lithotomy Position

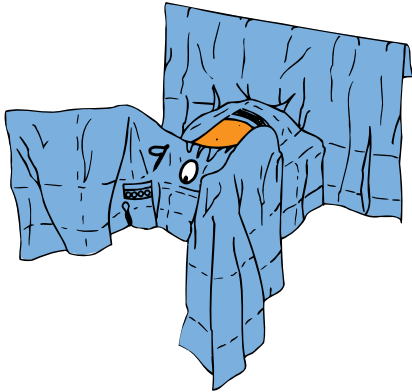

Overall Size	Adhesive Aperture Size	Drapes per Box	Boxes per Case
200 cm x 270 cm	35 cm x 46 cm	10	1

- Tube Organisers
- Perineal Adhesive Aperture: 12 cm x 15.5 cm

6665P001 Abdomino-Perineal Draping Pack

Product	Quantity	Overall Size	Packs per Box	Boxes per Case
Abdomino-Perineal Drape	1	200 cm x 270 cm	10	1
Instrument Table Cover	1	100 cm x 150 cm		
Mayo Stand Cover	1	80 cm x 145 cm		
Towel Drape	1	75 cm x 90 cm		
Hand Towels	4	–		

Incise Drapes

General Surgery Drapes / Packs

Orthopaedic Drapes / Packs

Cardiovascular and Cardiac Catheterisation Drapes / Packs

Obstetrics and Gynaecology Drapes / Packs

Urology Drapes / Packs

Ophthalmic Drapes / Packs

Head and Neck Drapes / Packs

Neurosurgery Drapes / Packs

Other Drapes and Accessories

Single Use Gowns – Standard and Reinforced

Custom Packs and Procedure Trays

Cross Reference by Product Number

Cross Reference by Product Name

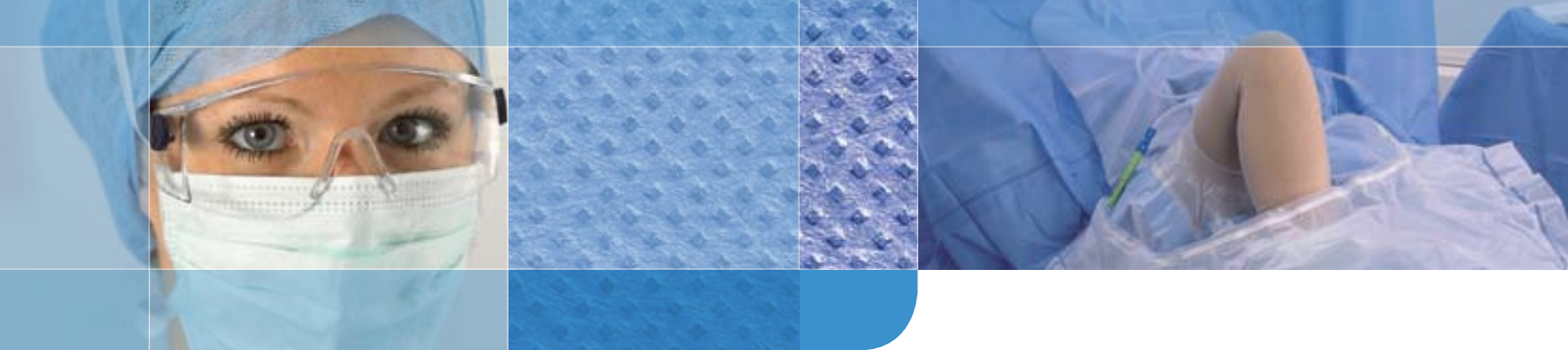

Orthopaedic

Orthopaedic surgery requires a draping system that maintains a sterile field throughout the procedure and reliably adheres to the skin. Heavy manipulation often occurs during orthopaedic procedures and drapes need to be able to withstand this.

Superior Strength and Comfort

The material of the Steri-Drape range of surgical drapes is strong enough to withstand the most arduous procedures and manipulation. They are soft and pliable for easy application.

Impervious to Strikethrough

A drape that allows fluid strikethrough, and thus bacteria transfer, compromises the sterile field, which increases the risk of Surgical Site Infection. That is why a drape that is impervious to liquid is so important.

Reliable Adhesion

3M is a leader in adhesive technology, and has applied this expertise to provide surgical drapes with consistently reliable adhesion to the skin or wound edge. 3M incise drapes adhere securely to wound edges, even during heavy retraction and irrigation, providing a barrier to bacteria on the skin.

Fluid Control Features

3M surgical drapes effectively control and contain fluid. The absorbent top layer soaks up spills and splatters, keeping fluid off the drape surface while the film part of the material maintains an impervious barrier. Many 3M surgical drapes have fluid collection pouches, which channel and collect body and irrigation fluids.

3M™ loban™ 2 Antimicrobial Incise Drapes

loban 2 antimicrobial incise drapes contain iodophor which is slowly released onto the skin surface giving continuous and controlled antimicrobial activity throughout the surgical procedure. An loban incise area is featured in some speciality drapes. loban incise drapes are also available as separate items.



Orthopaedic Drapes / Packs

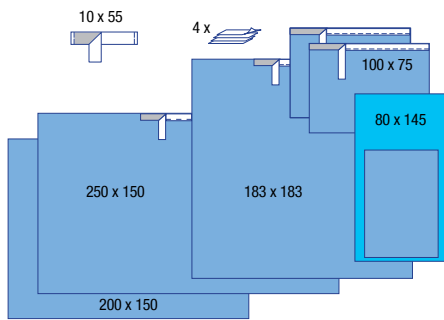

9000 Basic Surgical Pack

Product	Quantity	Overall Size	Packs per Box	Boxes per Case
Operation Tape	1	10 cm x 55 cm	7	2
Hand Towels	4	–		
Mayo Stand Cover	1	80 cm x 145 cm		
Adhesive Towel Drapes	2	100 cm x 75 cm		
Adhesive Drape Sheet (M)	1	183 cm x 183 cm		
Adhesive Drape Sheet (L)	1	250 cm x 150 cm		
Instrument Table Cover	1	200 cm x 150 cm		

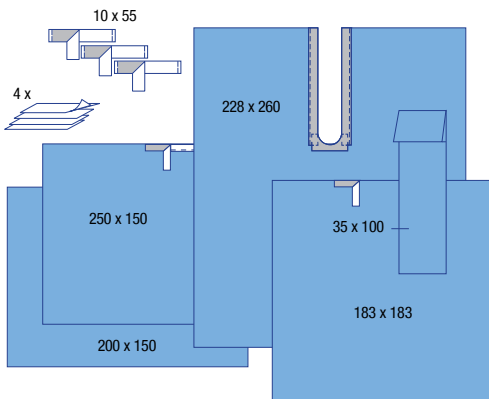

9002 Orthopaedic Surgical Pack without Mayo

Product	Quantity	Overall Size	Packs per Box	Boxes per Case
Operation Tape	3	10 cm x 55 cm	5	2
Hand Towels	4	–		
Legging	1	35 cm x 100 cm		
Adhesive Drape Sheet (M)	1	183 cm x 183 cm		
Adhesive Split Sheet	1	228 cm x 260 cm		
Adhesive Drape Sheet (L)	1	250 cm x 150 cm		
Instrument Table Cover	1	200 cm x 150 cm		

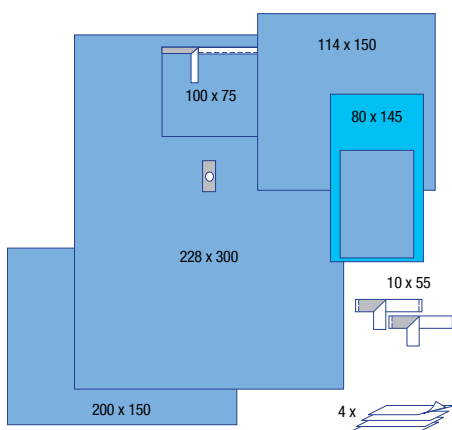

9004 Extremity Surgical Pack

Product	Quantity	Overall Size	Packs per Box	Boxes per Case
Operation Tape	2	10 cm x 55 cm	5	2
Hand Towels	4	–		
Mayo Stand Cover	1	80 cm x 145 cm		
Drape Sheet	1	114 cm x 150 cm		
Adhesive Towel Drape	1	100 cm x 75 cm		
Extremity Drape	1	228 cm x 300 cm		
Instrument Table Cover	1	200 cm x 150 cm		

KEY	Repellent Fabric	Blue Polyethylene Film	Clear Polyethylene Film	Absorbent Impervious Fabric
	Extra Absorbent Material	3M™ Ioban™ Antimicrobial Incise Film	3M™ Steri-Drape™ Incise Film	Clear Elastomeric Film
	Adhesive Area	Blue Elastomeric Film		

Dimensions are approximate

Orthopaedic Drapes / Packs

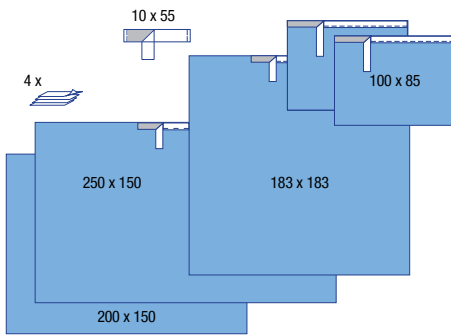

9010 Basic Surgical Pack without Mayo

Product	Quantity	Overall Size	Packs per Box	Boxes per Case
Operation Tape	1	10 cm x 55 cm	7	2
Hand Towels	4	–		
Adhesive Towel Drapes	1	100 cm x 80 cm		
Adhesive Drape Sheet (M)	2	183 cm x 183 cm		
Adhesive Drape Sheet (L)	1	250 cm x 150 cm		
Instrument Table Cover	1	200 cm x 150 cm		

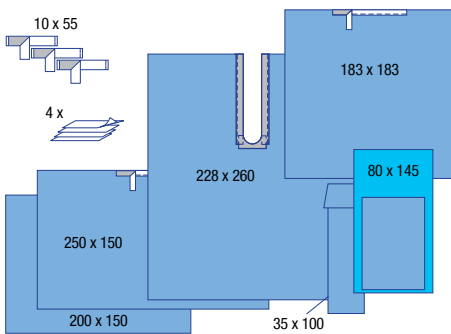

9012 Orthopaedic Surgical Pack

Product	Quantity	Overall Size	Packs per Box	Boxes per Case
Operation Tape	3	10 cm x 55 cm	5	2
Hand Towels	4	–		
Mayo Stand Cover	1	80 cm x 145 cm		
Legging	1	35 cm x 100 cm		
Adhesive Drape Sheet (M)	1	183 cm x 183 cm		
Adhesive Split Sheet	1	228 cm x 260 cm		
Adhesive Drape Sheet (L)	1	150 cm x 250 cm		
Instrument Table Cover	1	200 cm x 150 cm		

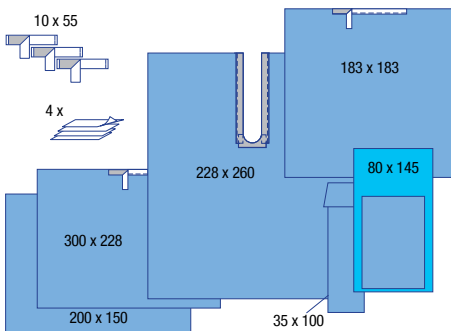

9012L Orthopaedic Surgical Pack

Product	Quantity	Overall Size	Packs per Box	Boxes per Case
Operation Tape	3	10 cm x 55 cm	4	2
Hand Towels	4	–		
Mayo Stand Cover	1	80 cm x 145 cm		
Legging	1	35 cm x 100 cm		
Adhesive Drape Sheet (M)	1	183 cm x 183 cm		
Adhesive Split Sheet	1	228 cm x 260 cm		
Adhesive Drape Sheet (XL)	1	300 cm x 228 cm		
Instrument Table Cover	1	200 cm x 150 cm		

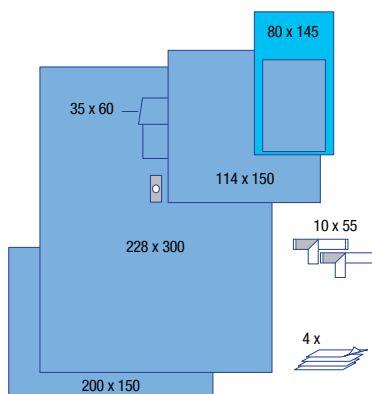

9014 Extremity Surgical Pack

Product	Quantity	Overall Size	Packs per Box	Boxes per Case
Operation Tape	2	10 cm x 55 cm	5	2
Hand Towels	4	–		
Mayo Stand Cover	1	80 cm x 145 cm		
Drape Sheet	1	114 cm x 150 cm		
Adhesive Towel Drape	1	35 cm x 60 cm		
Extremity Drape	1	228 cm x 300 cm		
Instrument Table Cover	1	200 cm x 150 cm		

Orthopaedic Drapes / Packs

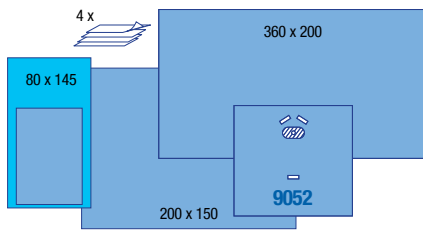

9015 Hand Pack

Product	Quantity	Overall Size	Packs per Box	Boxes per Case
Hand Drape	1	360 cm x 200 cm	7	2
Hand Towels	4	–		
Mayo Stand Cover	1	80 cm x 145 cm		
Instrument Table Cover	1	200 cm x 150 cm		

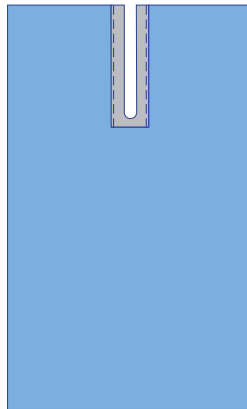

Adhesive Split Sheets

	NPC Code	Overall Size	Drapes per Box	Boxes per Case
9043 Split Size 7 x 70 cm	VJD154	150 cm x 183 cm	30	2
9044 Split Size 7 x 70 cm	VJD155	150 cm x 250 cm	25	2
9045 Split Size 20 x 100 cm	VJD156	228 cm x 260 cm	15	2

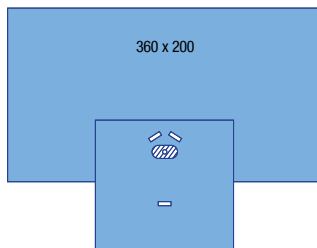

9052 Hand Drape

Overall Size	Aperture Size	Drapes per Box	Boxes per Case
360 cm x 200 cm	3 cm	9	2

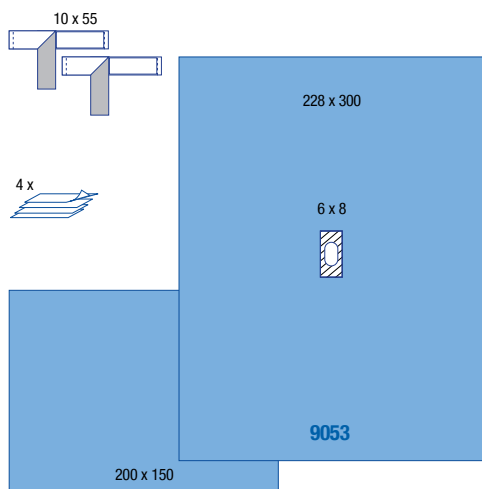

9053 Extremity Drape

Overall Size	Aperture Size	Drapes per Box	Boxes per Case
228 cm x 300 cm	6 cm x 8 cm	10	2

9053P Basic Extremity Pack

Product	Quantity	Overall Size	Packs per Box	Boxes per Case
Hand Towels	4	–	8	2
Operation Tapes	2	10 cm x 55 cm		
Extremity Drape	1	228 cm x 300 cm		
Instrument Table Cover	1	200 cm x 150 cm		

KEY	Repellent Fabric	Blue Polyethylene Film	Clear Polyethylene Film	Absorbent Impervious Fabric
	Extra Absorbent Material	3M™ Ioban™ Antimicrobial Incise Film	3M™ Steri-Drape™ Incise Film	Clear Elastomeric Film
	Adhesive Area			
		Blue Elastomeric Film		

Dimensions are approximate

Orthopaedic Drapes / Packs

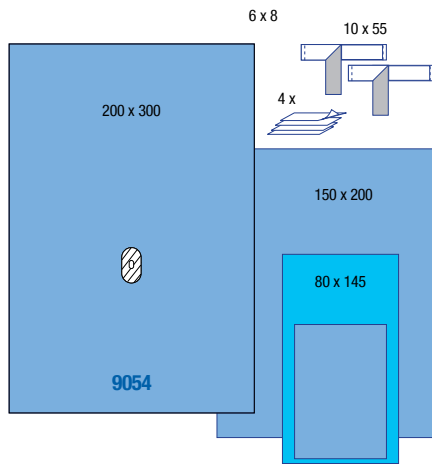

9054 Foot / Hand Drape

Overall Size	Aperture Size	Drapes per Box	Boxes per Case
200 cm x 300 cm	3 cm	12	2

9054P Foot / Hand Pack

Product	Quantity	Overall Size	Packs per Box	Boxes per Case
Operation Tapes	2	10 cm x 55 cm	7	2
Hand Towels	4	–		
Mayo Stand Cover	1	80 cm x 145 cm		
Food/Hand Drape	1	200 cm x 300 cm		
Instrument Table Cover	1	150 cm x 200 cm		

9055 One-Piece Hip Drape with Side Pouches

Overall Size	Aperture Size	Drapes per Box	Boxes per Case
300 cm x 353 cm	19 cm x 19 cm	8	2

9055P Hip Pack

Product	Quantity	Overall Size	Packs per Box	Boxes per Case
Operation Tapes	3	10 cm x 55 cm	4	2
Hip Drape	1	300 cm x 353 cm		
Reinforced Mayo Stand Cover	1	80 cm x 145 cm		
Legging	1	35 cm x 100 cm		
Adhesive Split Sheet	1	228 cm x 260 cm		
Instrument Table Cover	1	200 cm x 150 cm		

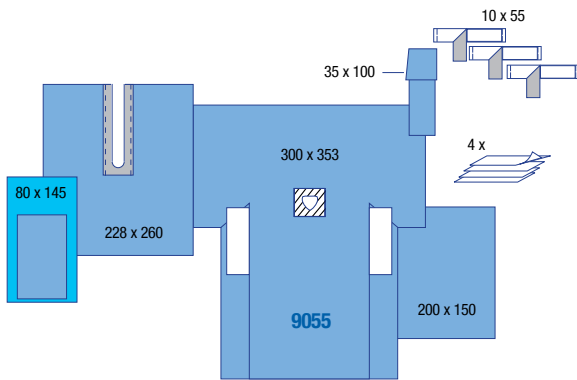

9056 Bilateral Foot Drape

Overall Size	Drapes per Box	Boxes per Case
195 cm x 300 cm	13	2

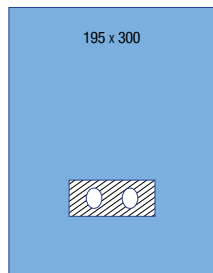

9057 Extremity Drape

Overall Size	Drapes per Box	Boxes per Case
305 cm x 292 cm	10	2

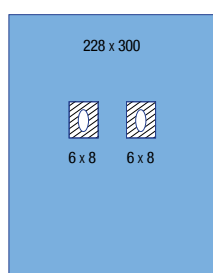
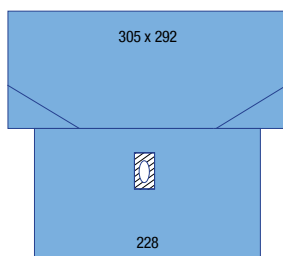

9058 Bilateral Knee Drape

Overall Size	Drapes per Box	Boxes per Case
228 cm x 300 cm	10	2

Orthopaedic Drapes / Packs

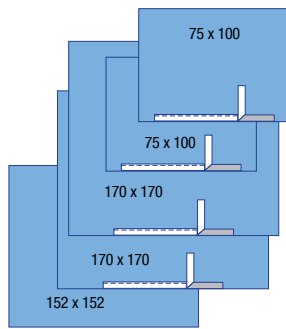

9100 General Pack

Product	Quantity	Overall Size	Packs per Box	Boxes per Case
Adhesive Side Towel	2	100 cm x 75 cm	7	2
Adhesive Drape Sheet	2	170 cm x 170 cm		
Back Table Cover	1	152 cm x 152 cm		

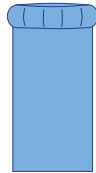

Stockinette

	Overall Size	Drapes per Box	Boxes per Case
9109	20 cm x 76 cm	20	1
9110	30 cm x 122 cm	20	1

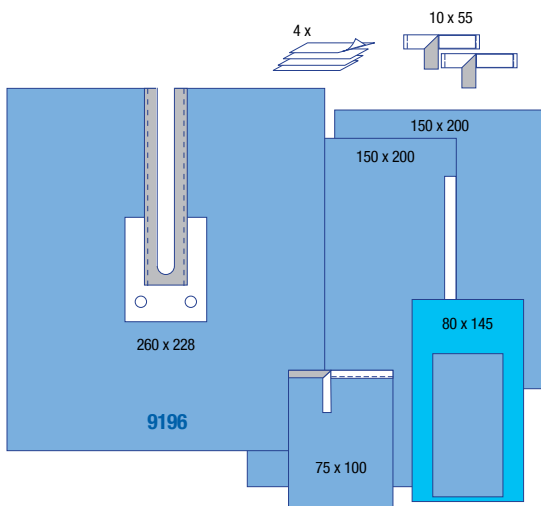

9196 Shoulder Split Sheet with Pouch

Overall Size	Drapes per Box	Boxes per Case
228 cm x 260 cm	10	2

- Fluid Collection Pouch
- 2 Exit Ports

9196P Shoulder Arthroscopy Pack

Product	Quantity	Overall Size	Packs per Box	Boxes per Case
Operation Tapes	2	10 cm x 55 cm	5	2
Hand Towels	4	–		
Mayo Stand Cover	1	80 cm x 145 cm		
Adhesive Towel Drape	1	75 cm x 100 cm		
Adhesive Drape Sheet	1	150 cm x 250 cm		
Shoulder Split Sheet with Pouch	1	228 cm x 260 cm		
Instrument Table Cover	1	150 cm x 200 cm		

KEY	Repellent Fabric	Blue Polyethylene Film	Clear Polyethylene Film	Absorbent Impervious Fabric
	Extra Absorbent Material	3M™ Ioban™ Antimicrobial Incise Film	3M™ Steri-Drape™ Incise Film	Clear Elastomeric Film
	Adhesive Area	Blue Elastomeric Film		

Dimensions are approximate

Orthopaedic Drapes / Packs

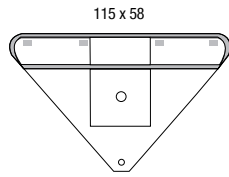

1007 Arthroscopy Fluid Collection Pouch

Overall Size	Drapes per Box	Boxes per Case
115 cm x 58 cm	10	4

- Adhesive Strips
- 1 Exit Port

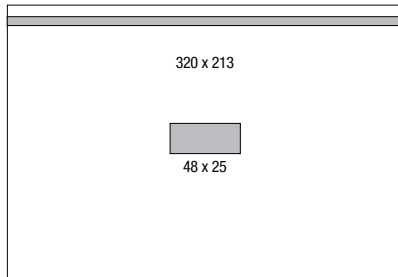

1014 Patient Isolation Drape

Overall Size	3M™ Steri-Drape™ Incise Area	Drapes per Box	Boxes per Case
320 cm x 213 cm	48 cm x 25 cm	5	4

- Adhesive Strip Along Top
- Clear Plastic

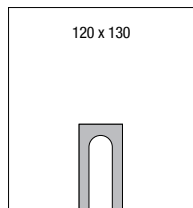

1015 U-Drape

Overall Size	Drapes per Box	Boxes per Case
120 cm x 130 cm	10	4

- U-Slot Aperture with Adhesive
- Clear Plastic

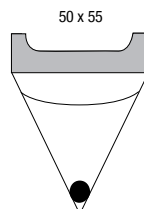

1016 Irrigation Pouch

Overall Size	Drapes per Box	Boxes per Case
50 cm x 55 cm	10	4

- Adhesive Strip
- 1 Exit Port

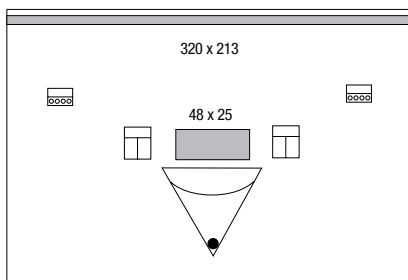

1017 Isolation Drape with Incise Film and Pouch

Overall Size	3M™ Steri-Drape™ Incise Area	Drapes per Box	Boxes per Case
320 cm x 213 cm	48 cm x 25 cm	5	4

- Fluid Collection Pouch
- 1 Exit Port
- 2 Instrument Pouches
- 2 Tube and Cord Organisers
- Adhesive Strip Along Top
- Clear Plastic

1017P001 Patient Isolation Pack

Product	Quantity	Overall Size	Packs per Box	Boxes per Case
Patient Isolation Drape	1	320 cm x 213 cm	12	1
Instrument Table Cover	1	200 cm x 150 cm		
Mayo Stand Cover	1	80 cm x 145 cm		
Hand Towels	4	—		

Orthopaedic Drapes / Packs

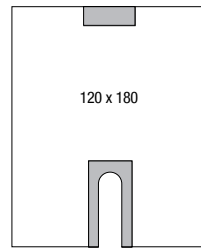

1019 Long U-Drape

Overall Size	Drapes per Box	Boxes per Case
120 cm x 180 cm	10	4

- U-Slot Aperture with Adhesive
- Adhesive Patch
- Clear Plastic

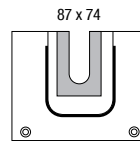

1067 U-Pouch

Overall Size	Drapes per Box	Boxes per Case
87 cm x 74 cm	5	4

- U-Slot Aperture with Adhesive
- 2 Exit Ports

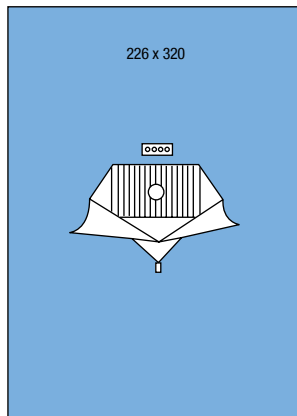

1094 Arthroscopy Sheet with Pouch

Overall Size	Drapes per Box	Boxes per Case
226 cm x 320 cm	20	1

- Fluid Collection Pouch
- 1 Exit Port
- Tube and Cord Organiser

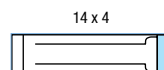

1115 Tube Organiser

Overall Size	Drapes per Box	Boxes per Case
14 cm x 4 cm	100	4

- KEY**
- Repellent Fabric
 - Blue Polyethylene Film
 - Clear Polyethylene Film
 - Absorbent Impervious Fabric
 - Extra Absorbent Material
 - 3M™ Ioban™ Antimicrobial Incise Film
 - 3M™ Steri-Drape™ Incise Film
 - Clear Elastomeric Film
 - Adhesive Area
 - Blue Elastomeric Film

Dimensions are approximate

Orthopaedic Drapes / Packs

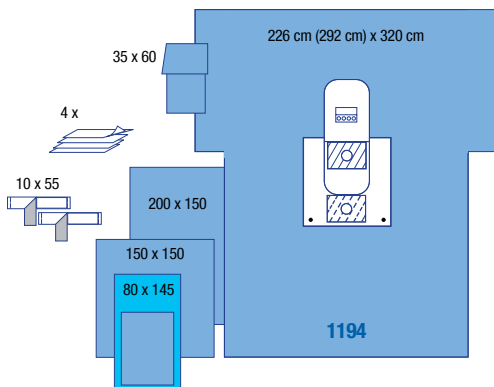

1194 Arthroscopy Sheet with Pouch

Overall Size	Drapes per Box	Boxes per Case
226 cm (292 cm) x 320 cm	5	1

- Fluid Collection Pouch
- 2 Exit Ports
- Tube and Cord Organiser

1194P Arthroscopy Pack

Product	Quantity	Overall Size	Packs per Box	Boxes per Case
Hand Towels	4	–	4	2
Operation Tapes	2	10 cm x 55 cm		
Mayo Stand Cover	1	80 cm x 145 cm		
Drape Sheet	1	150 cm x 150 cm		
Legging	1	35 cm x 60 cm		
Arthroscopy Sheet with Pouch	1	226 cm (292 cm) x 320 cm		
Instrument Table Cover	1	200 cm x 150 cm		

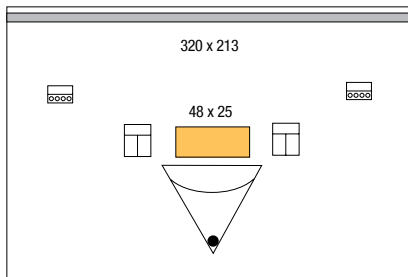

6617 Isolation Drape with 3M™ Ioban™ 2 Incise Film and Pouch

Overall Size	Ioban 2 incise area	Drapes per Box	Boxes per Case
320 cm x 213 cm	48 cm x 25 cm	5	4

- Fluid Collection Pouch
- 1 Exit Port
- 2 Instrument Pouches
- 2 Tube and Cord Organisers
- Adhesive Strip Along Top
- Clear Plastic

6617P001 Patient Isolation Pack with 3M™ Ioban™ 2 Incise Film and Pouch

Product	Quantity	Overall Size	Packs per Box	Boxes per Case
Patient Isolation Drape	1	–	14	1
Instrument Table Cover	1	10 cm x 55 cm		
Mayo Stand Cover	1	80 cm x 145 cm		
Hand Towels	4	150 cm x 150 cm		

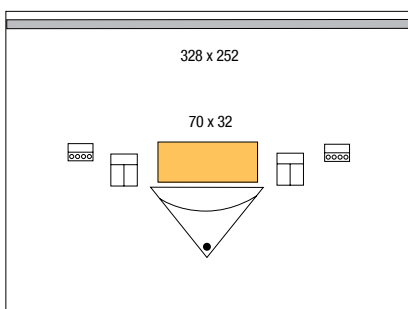

6619 Large Isolation Drape with 3M™ Ioban™ 2 Incise Film and Pouch

Overall Size	Ioban 2 incise area	Drapes per Box	Boxes per Case
328 cm x 252 cm	70 cm x 32 cm	5	1

- Fluid Collection Pouch
- 1 Exit Port
- 2 Instrument Pouches
- 2 Tube and Cord Organisers
- Adhesive Strip Along Top
- Clear Plastic

Incise Drapes

General Surgery Drapes / Packs

Orthopaedic Drapes / Packs

Cardiovascular and Cardiac Catheterisation Drapes / Packs

Obstetrics and Gynaecology Drapes / Packs

Urology Drapes / Packs

Ophthalmic Drapes / Packs

Head and Neck Drapes / Packs

Neurosurgery Drapes / Packs

Other Drapes and Accessories

Single Use Gowns – Standard and Reinforced

Custom Packs and Procedure Trays

Cross Reference by Product Number

Cross Reference by Product Name



Cardiovascular Cardiac Catheterisation

Most cardiothoracic procedures require drapes that can withstand heavy manipulation and reduce the likelihood of infection. There is often a large amount of fluid involved with these procedures and therefore drapes used should have fluid control features. Drapes that contain antimicrobial features can reduce the risk of surgical site infection which is very important in this type of surgery.

Superior Strength and Comfort

The material of the Steri-Drape range of surgical drapes is strong enough to withstand the most arduous procedures and manipulation. They are soft and pliable for easy application.

Impervious to Strikethrough

A drape that allows fluid strikethrough, and thus bacteria transfer, compromises the sterile field, which increases the risk of Surgical Site Infection. That is why a drape that is impervious to liquid is so important.

Fluid Control Features

3M surgical drapes effectively control and contain fluid. The absorbent top layer soaks up spills and splatters, keeping fluid off the drape surface while the film part of the material maintains an impervious barrier. Many 3M surgical drapes have fluid collection pouches, which channel and collect body and irrigation fluids.

3M™ Ioban™ 2 Antimicrobial Incise Drapes

Ioban 2 antimicrobial incise drapes contain iodophor which is slowly released onto the skin surface giving continuous and controlled antimicrobial activity throughout the surgical procedure. An Ioban incise area is featured in some speciality drapes. Ioban incise drapes are also available as separate items.

Reliable Adhesion

3M is a leader in adhesive technology, and has applied this expertise to provide surgical drapes with consistently reliable adhesion to the skin or wound edge. 3M incise drapes adhere securely to wound edges, even during heavy retraction and irrigation, providing a barrier to bacteria on the skin.

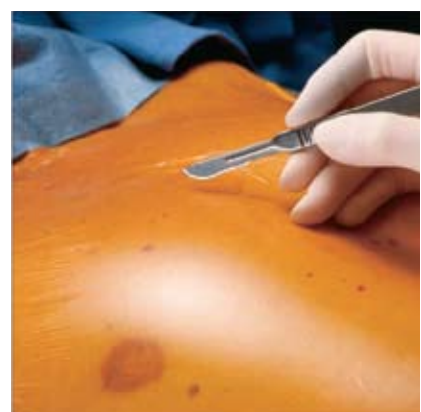

Cardiovascular Drapes and Cardiac Catheterisation Drapes / Packs

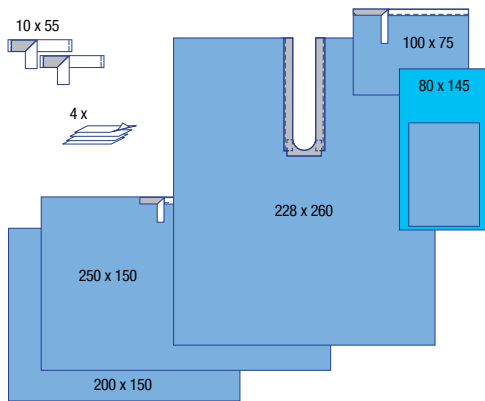

9018 Surgical Split Sheet Pack

Product	Quantity	Overall Size	Packs per Box	Boxes per Case
Operation Tapes	2	10 cm x 55 cm	6	2
Hand Towels	4	–		
Mayo Stand Cover	1	80 cm x 145 cm		
Adhesive Towel Drape	1	100 cm x 75 cm		
Adhesive Split Sheet	1	228 cm x 260 cm		
Adhesive Drape Sheet (L)	1	250 cm x 150 cm		
Instrument Table Cover	1	200 cm x 150 cm		

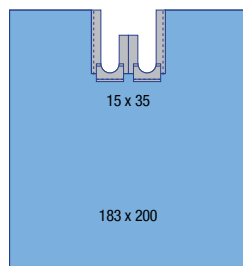

9046 Bilateral Split Sheet

Overall Size	Aperture Split	Drapes per Box	Boxes per Case
183 cm x 200 cm	15 cm x 35 cm	15	2

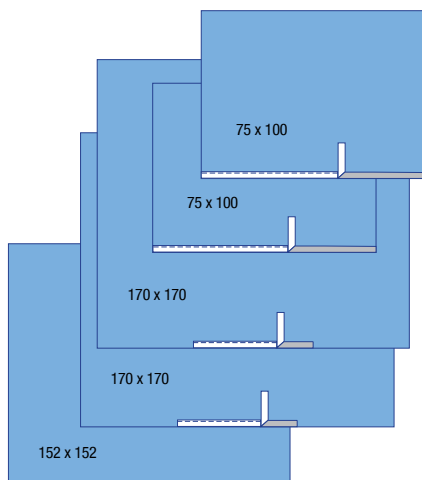

9100 General Pack

Product	Quantity	Overall Size	Packs per Box	Boxes per Case
Adhesive Side Towel	2	100 cm x 55 cm	7	2
Adhesive Drape Sheet	4	170 cm x 170 cm		
Back Table Cover	1	152 cm x 152 cm		

KEY	Repellent Fabric	Blue Polyethylene Film	Clear Polyethylene Film	Absorbent Impervious Fabric
	Extra Absorbent Material	3M™ Ioban™ Antimicrobial Incise Film	3M™ Steri-Drape™ Incise Film	Clear Elastomeric Film
	Adhesive Area	Blue Elastomeric Film		

Dimensions are approximate

Cardiovascular Drapes and Cardiac Catheterisation Drapes / Packs

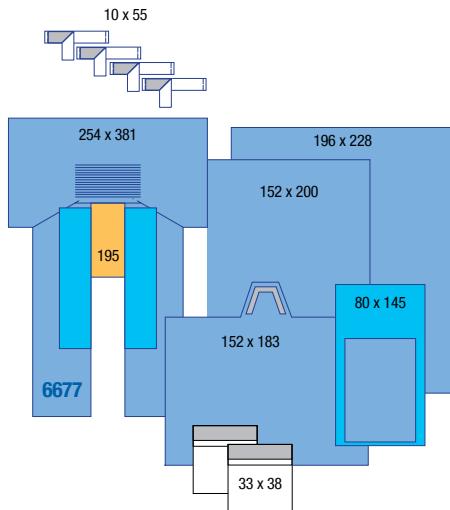

6677 Cardiovascular Sheet with 3M™ Ioban™ 2 Incise Film

Overall Size	Ioban 2 incise area	Drapes per Box	Boxes per Case
254 cm x 381 cm	41 cm x 92 cm	6	1

- Dual Side Pockets

6677P Cardiovascular Pack with 3M™ Ioban™ 2 Incise Film

Product	Quantity	Overall Size	Packs per Box	Boxes per Case
Cardiovascular Sheet	1	195 cm x 381 cm	4	1
Perinal Leg Sheet	1	152 cm x 183 cm		
Non Adhesive Drape Sheet	1	196 cm x 228 cm		
Mayo Stand Cover	1	80 cm x 145 cm		
Instrument Pouch	2	33 cm x 38 cm		
Operation Tapes	4	10 cm x 55 cm		
Instrument Table Cover	1	152 cm x 200 cm		

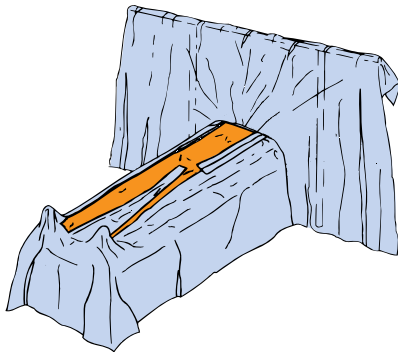

6681 3M™ Ioban™ 2 Cardiovascular Drape

Overall Size	Ioban 2 incise area	Drapes per Box	Boxes per Case
230 cm x 230 cm	see illustration	8	1

- Impervious Fabric
- Plastic Isolation Screen

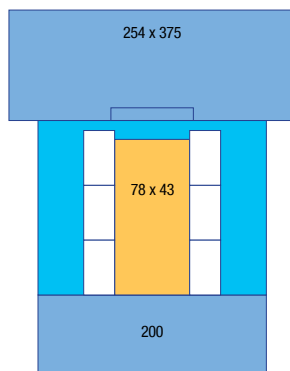

6682 Steri-Drape Cardio/Cest Drape with 3M™ Ioban™ 2 Incise Film

Overall Size	Ioban 2 incise area	Drapes per Box	Boxes per Case
254 cm x 375 cm	78 cm x 43 cm	8	1

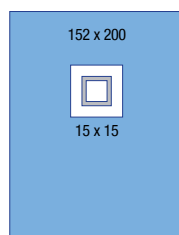

1034 CVC Drape

Overall Size	Drapes per Box	Boxes per Case
152 cm x 200 cm	22	2

Cardiovascular Drapes and Cardiac Catheterisation Drapes / Packs

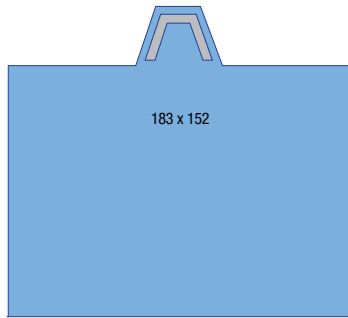

1083NS Perineal Leg Sheet

Overall Size	Items per Box	Boxes per Case
183 cm x 152 cm	90	1

- Only available as Non Sterile. To be included in CP/CPT's

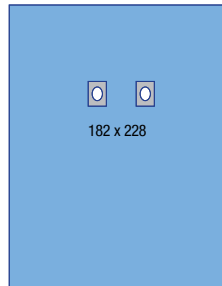

1090 Femoral Angiography Drape

Overall Size	Oval Aperture Split	Drapes per Box	Boxes per Case
182 cm x 228 cm	6 cm x 9 cm	20	1

- 2 Adhesive Patches: 11.5 cm x 14 cm

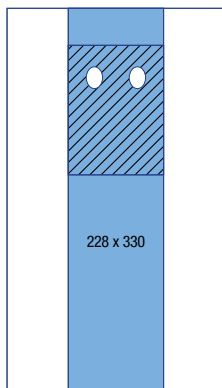

1190NS Angiography Drape

Overall Size	Drapes per Box	Boxes per Case
228 cm x 330 cm	33	1

- Only available as Non Sterile. To be included in CP/CPT's

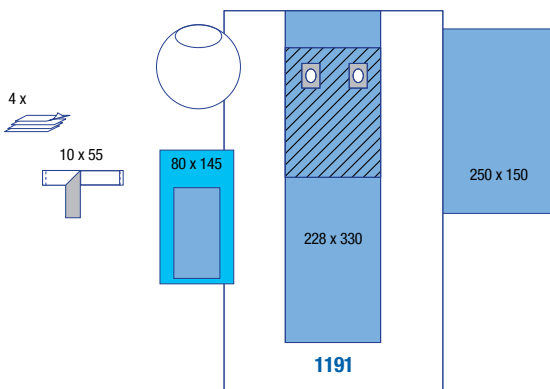

1191 Femoral Angiography Drape

Overall Size	Oval Aperture Split	Drapes per Box	Boxes per Case
228 cm x 330 cm	6 cm x 9 cm	20	1

- Highly Absorbent Area: 91.4cm x 122cm
 - 2 Adhesive Patches: 11.5cm x 14cm
 - Transparent Side and End Panels
- For X-ray equipment covers see page 93

1191P Angiography Packs

Product	Quantity	Overall Size	Packs per Box	Boxes per Case
Operation Tape	1	10 cm x 55 cm	7	2
Hand Towels	4	–		
Mayo Stand Cover	1	80 cm x 145 cm		
Banded Bag	1	91 cm		
Angiography Drape	1	228 cm x 330 cm		
Instrument Table Cover	1	200 cm x 150 cm		

- KEY**
- Repellent Fabric
 - Blue Polyethylene Film
 - Clear Polyethylene Film
 - Absorbent Impervious Fabric
 - Extra Absorbent Material
 - 3M™ Ioban™ Antimicrobial Incise Film
 - 3M™ Steri-Drape™ Incise Film
 - Clear Elastomeric Film
 - Adhesive Area
 - Blue Elastomeric Film

Dimensions are approximate

Incise Drapes

General Surgery Drapes / Packs

Orthopaedic Drapes / Packs

Cardiovascular and Cardiac Catheterisation Drapes / Packs

Obstetrics and Gynaecology Drapes / Packs

Urology Drapes / Packs

Ophthalmic Drapes / Packs

Head and Neck Drapes / Packs

Neurosurgery Drapes / Packs

Other Drapes and Accessories

Single Use Gowns – Standard and Reinforced

Custom Packs and Procedure Trays

Cross Reference by Product Number

Cross Reference by Product Name

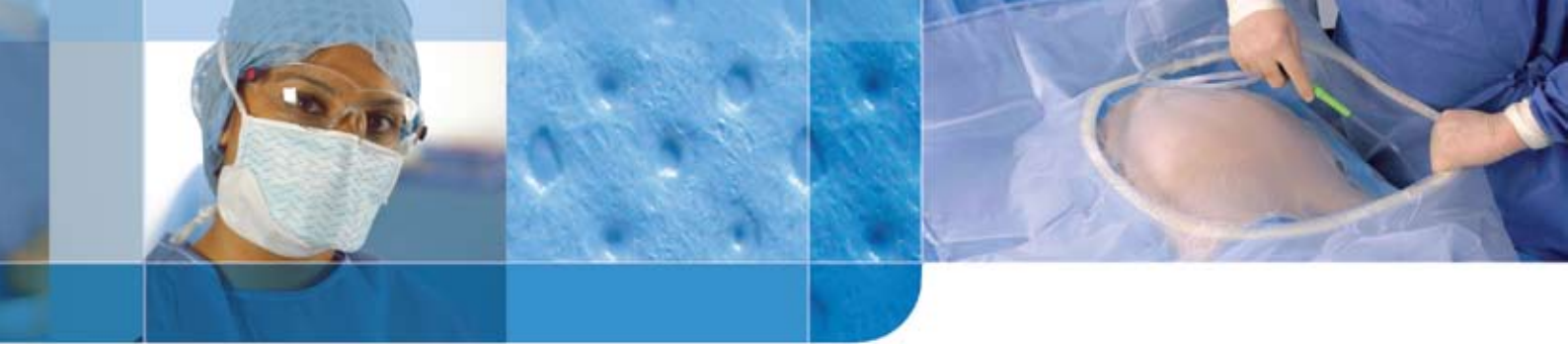

Obstetrics and Gynaecology

Some obstetric procedures such as caesarean section present challenges for a draping system. Large amounts of blood and amniotic fluid present mean a drape must have excellent fluid control features to ensure the patient remains dry throughout the procedure and reduces the likelihood of fluid spillages that could be a health and safety hazard to healthcare workers. Ease of application is imperative as these procedures are often emergencies.

Fluid Control Features

3M surgical drapes effectively control and contain fluid. The absorbent top layer soaks up spills and splatters, keeping fluid off the drape surface while the film part of the material maintains an impervious barrier. Many 3M surgical drapes have fluid collection pouches, which channel and collect body and irrigation fluids.

Superior Strength and Comfort

The material of the Steri-Drape range of surgical drapes is strong enough to withstand the most arduous procedures and manipulation. They are soft and pliable for easy application.

Impervious to Strikethrough

A drape that allows fluid strikethrough, and thus bacteria transfer, compromises the sterile field, which increases the risk of Surgical Site Infection. That is why a drape that is impervious to liquid is so important.

3M Range

3M surgical drapes are available individually and in specialised packs to cover most surgical procedures. The contents of each draping pack are tailored to match the requirements of each and every procedure. Fully customised packs are also available, to save time and minimise waste.

3M™ Ioban™ 2 Antimicrobial Incise Drapes

Ioban 2 antimicrobial incise drapes contain iodophor which is slowly released onto the skin surface giving continuous and controlled antimicrobial activity throughout the surgical procedure. An Ioban incise area is featured in some speciality drapes. Ioban incise drapes are also available as separate items.



Reliable Adhesion

3M is a leader in adhesive technology, and has applied this expertise to provide surgical drapes with consistently reliable adhesion to the skin or wound edge. 3M incise drapes adhere securely to wound edges, even during heavy retraction and irrigation, providing a barrier to bacteria on the skin.

Obstetrics and Gynaecology Drapes / Packs

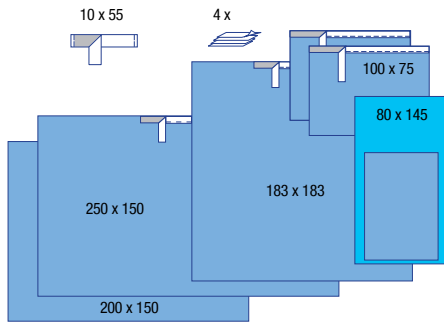

9000 Basic Surgical Pack

Product	Quantity	Overall Size	Packs per Box	Boxes per Case
Operation Tapes	1	10 cm x 55 cm	7	2
Hand Towels	4	–		
Mayo Stand Cover	1	80 cm x 145 cm		
Adhesive Towel Drape	2	75 cm x 100 cm		
Adhesive Drape Sheet (M)	1	183 cm x 183 cm		
Adhesive Drape Sheet (L)	1	250 cm x 150 cm		
Instrument Table Cover	1	200 cm x 150 cm		

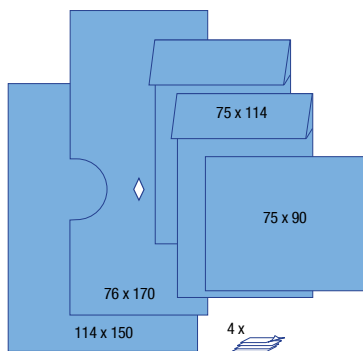

9003 Cystoscopy Surgical Pack

Product	Quantity	Overall Size	Packs per Box	Boxes per Case
Drape Sheet	1	75 cm x 90 cm	10	2
Hand Towels	4	–		
Leggings (pair)	1	75 cm x 114 cm		
Perineal Aperture Drape	1	76 cm x 170 cm		
Instrument Table Cover	1	114 cm x 150 cm		

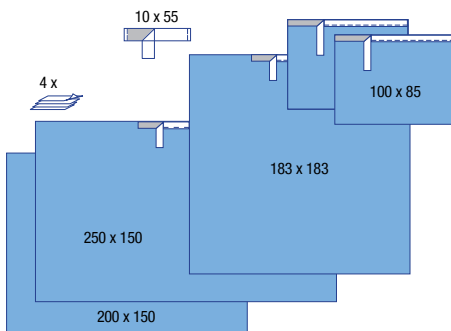

9010 Basic Surgical Pack without Mayo

Product	Quantity	Overall Size	Packs per Box	Boxes per Case
Operation Tapes	1	10 cm x 55 cm	7	2
Hand Towels	4	–		
Adhesive Towel Drape	2	100 cm x 85 cm		
Adhesive Drape Sheet (M)	1	183 cm x 183 cm		
Adhesive Drape Sheet (L)	1	250 cm x 150 cm		
Instrument Table Cover	1	200 cm x 150 cm		

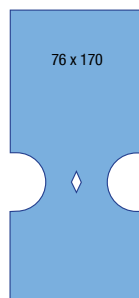

9023 Perineal Aperture Drape

Overall Size	Drapes per Box	Boxes per Case
76 cm x 170 cm	25	4

KEY	Repellent Fabric	Blue Polyethylene Film	Clear Polyethylene Film	Absorbent Impervious Fabric
	Extra Absorbent Material	3M™ Ioban™ Antimicrobial Incise Film	3M™ Steri-Drape™ Incise Film	Clear Elastomeric Film
	Adhesive Area	Blue Elastomeric Film	Dimensions are approximate	

Obstetrics and Gynaecology Drapes / Packs

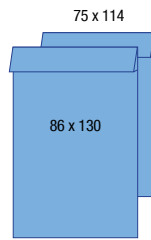

9040 Leggings (pair)

Overall Size	Drapes per Box	Boxes per Case
75 cm x 114 cm	12	4

9040L Leggings (pair)

Overall Size	Drapes per Box	Boxes per Case
86 cm x 130 cm	8	4

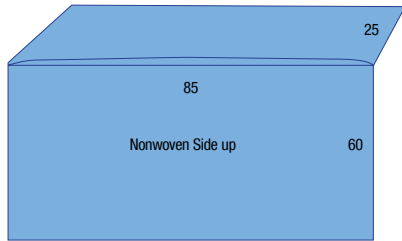

9066 Under Buttock Drape with Cuff

Overall Size	Drapes per Box	Boxes per Case
85 cm x 85 cm	30	4

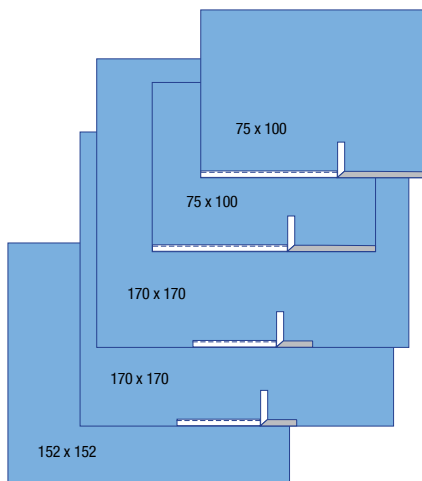

9100 General Pack

Product	Quantity	Overall Size	Packs per Box	Boxes per Case
Adhesive Side Towel	2	100 cm x 75 cm	7	2
Adhesive Drape Sheet	2	170 cm x 170 cm		
Back Table Cover	1	152 cm x 152 cm		

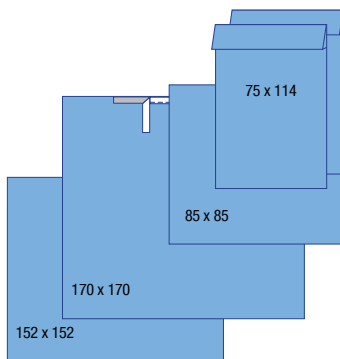

9105 Lithotomy Pack – Under Buttock

Product	Quantity	Overall Size	Packs per Box	Boxes per Case
Under Buttocks Drape with Cuff	1	85 cm x 85 cm	7	2
Leggings	2	75 cm x 114 cm		
Adhesive Drape Sheet	1	170 cm x 170 cm		
Back Table Cover	1	152 cm x 152 cm		

Obstetrics and Gynaecology Drapes / Packs

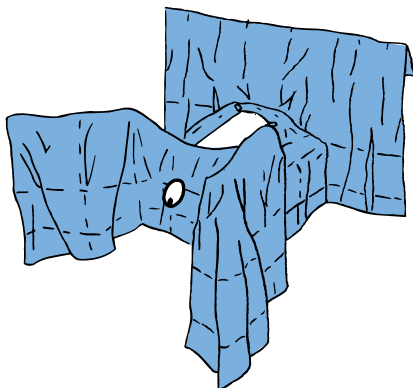
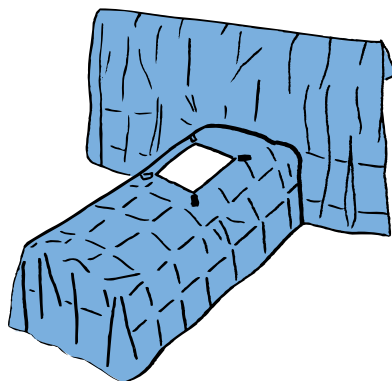
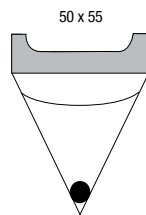
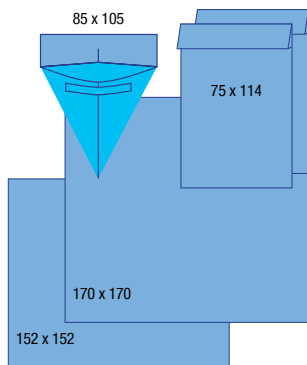

9106 Lithotomy Pack – with Pouch

Product	Quantity	Overall Size	Packs per Box	Boxes per Case
Under Buttocks Drape with Pouch	1	85 cm x 105 cm	7	2
Leggings	2	75 cm x 114 cm		
Adhesive Drape Sheet	1	170 cm x 170 cm		
Back Table Cover	1	152 cm x 152 cm		

1016 Irrigation Pouch

Overall Size	Drapes per Box	Boxes per Case
50 cm x 55 cm	10	4

- Adhesive Strip
- 1 Exit Port

1031 Laparoscopic Drape - Supine Position

Overall Size	Oval Aperture Split	Drapes per Box	Boxes per Case
285 cm x 182 cm	27 cm x 30 cm	10	2

- 4 Tube Organisers (ref. 1115)

1032 Laparoscopic Drape - Lithotomy Position

Overall Size	Oval Aperture Split	Drapes per Box	Boxes per Case
241 cm x 228 cm	27 cm x 30 cm	8	2

- 4 Tube Organisers (ref. 1115)
- Perineal Adhesive Aperture: 12cm x 15.5cm

1032P Laparoscopic Drape Pack / Lithotomy Position

Product	Quantity	Overall Size	Packs per Box	Boxes per Case
Laparoscopy Drape	1	241 cm x 228 cm	5	2
Instrument Table Cover		200 cm x 150 cm		
Hand Towels	4	–		
Mayo Stand Cover	1	80 cm x 145 cm		

KEY	Repellent Fabric	Blue Polyethylene Film	Clear Polyethylene Film	Absorbent Impervious Fabric
	Extra Absorbent Material	3M™ Ioban™ Antimicrobial Incise Film	3M™ Steri-Drape™ Incise Film	Clear Elastomeric Film
	Adhesive Area	Blue Elastomeric Film		

Dimensions are approximate

Obstetrics and Gynaecology Drapes / Packs

23 x 45

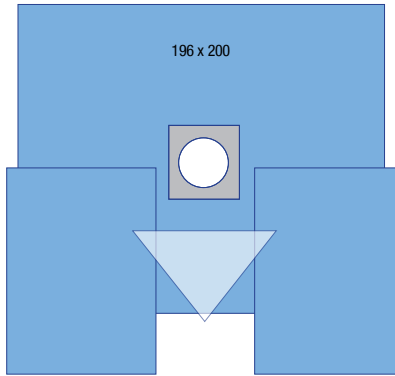
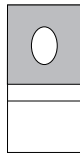

1072 Aperture Pouch Drape

Overall Size	Adhesive Size	Oval Aperture Size	Drapes per Box	Boxes per Case
23 cm x 45 cm	23 cm x 25 cm	11 cm x 8.5 cm	7	2

1078 Perineal Drape with Pouch

Overall Size	Drapes per Box	Boxes per Case
196 cm x 200 cm	10	2

- Elastic Aperture
- Neoprene Finger Cot
- Large Integrated Fluid Collection Pouch with Filter and Exit Port

4 x

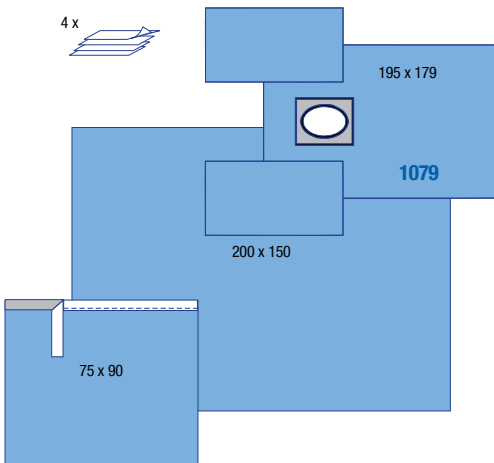

1079 Gynaecological Drape

Overall Size	Adhesive Aperture Size	Drapes per Box	Boxes per Case
195 cm x 179 cm	12 cm x 9 cm	14	2

1079P Gynaecological Pack

Product	Quantity	Overall Size	Packs per Box	Boxes per Case
Gynaecology Drape	1	195 cm x 179 cm	7	2
Instrument Table Cover	1	100 cm x 150 cm		
Towel Drape	1	75 cm x 90 cm		

4 x

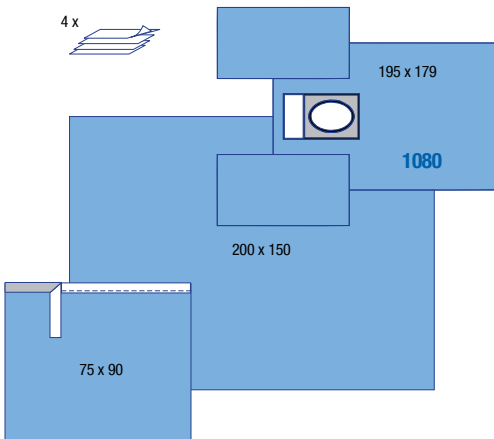

1080 Gynaecological Drape with 1072 Pouch

Overall Size	Adhesive Aperture Size	Drapes per Box	Boxes per Case
195 cm x 179 cm	12 cm x 9 cm	14	2

- Available as a single box

1080P Gynaecological Pack with 1072 Pouch

Product	Quantity	Overall Size	Packs per Box	Boxes per Case
Gynaecology Drape	1	195 cm x 179 cm	7	2
Instrument Table Cover	1	200 cm x 150 cm		
Towel Drape	1	75 cm x 90 cm		

Obstetrics and Gynaecology Drapes / Packs

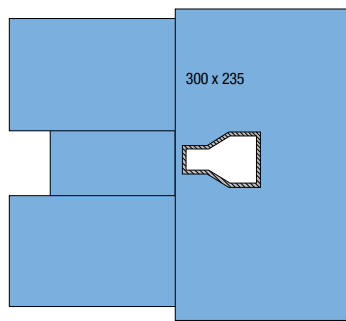

1082 TVT/TOT Drape

Overall Size	Aperture Size	Drapes per Box	Boxes per Case
235 cm x 300 cm	11 cm x 8.5 cm	10	4

- Pouch Size: 15.5 cm x 23 cm

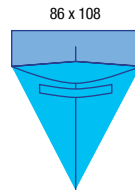

1084 Under Buttocks Drape with Pouch

Overall Size	Drapes per Box	Boxes per Case
86 cm x 108 cm	30	4

- Cuff Size: 25.4 cm
- Fluid Collection Pouch

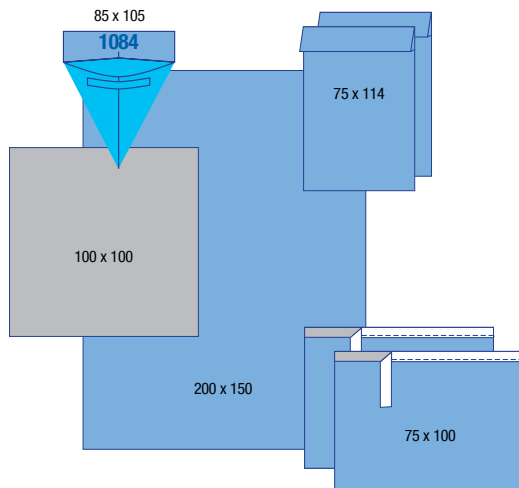

1084P Delivery Pack

Product	Quantity	Overall Size	Packs per Box	Boxes per Case
Under Buttocks Drape with Pouch	1	86 cm x 106 cm	7	2
Leggings	2	75 cm x 114 cm		
Adhesive Towel Drape	2	75 cm x 100 cm		
Drape Sheet	1	100 cm x 100 cm		
Instrument Table Cover	1	150 cm x 200 cm		

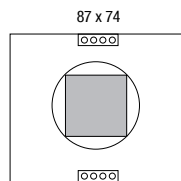

2057 Incise Pouch

Overall Size	3M™ Steri-Drape™ Incise Area	Drapes per Box	Boxes per Case
87 cm x 74 cm	30 cm x 30 cm	10	4

- 360-Degree Fluid Collection Pouch
- Tube Organisers

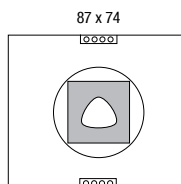

2058 Aperture Pouch

Overall Size	Fenestrated Incise Areaze	Drapes per Box	Boxes per Case
87 cm x 74 cm	30 cm x 30 cm	10	4

- 360-Degree Fluid Collection Pouch
- Tube Organisers

KEY	Repellent Fabric	Blue Polyethylene Film	Clear Polyethylene Film	Absorbent Impervious Fabric
	Extra Absorbent Material	3M™ Ioban™ Antimicrobial Incise Film	3M™ Steri-Drape™ Incise Film	Clear Elastomeric Film
	Adhesive Area	Blue Elastomeric Film		

Dimensions are approximate

Obstetrics and Gynaecology Drapes

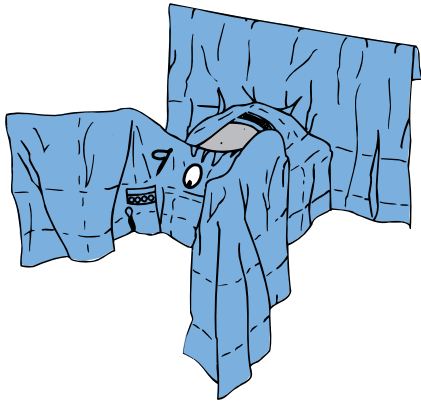

2065 Abdomino-Perineal Drape - Lithotomy Position

Overall Size	3M™ Steri-Drape™ 2 Incise Area	Drapes per Box	Boxes per Case
195 cm x 271 cm	41 cm x 45 cm	8	1

- Tube Organisers
- Perineal Adhesive Aperture: 12 cm x 15.5 cm

2065P Abdomino-Perineal Draping Pack

Product	Quantity	Overall Size	Packs per Box	Boxes per Case
Abdomino-Perineal Drape	1	195 cm x 271 cm	5	2
Instrument Table Cover	1	100 cm x 150 cm		
Mayo Stand Cover	1	80 cm x 145 cm		
Towel Drape	1	75 cm x 90 cm		
Hand Towels	4	-		

6657 Pouch with 3M™ Ioban™ 2 Incise Film

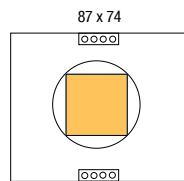

Overall Size	Oval Aperture Split	Drapes per Box	Boxes per Case
87 cm x 74 cm	30 cm x 30 cm	10	4

- 360-Degree Fluid Collection Pouch
- Tube Organisers

6658 Large Pouch with 3M™ Ioban™ 2 Incise Film

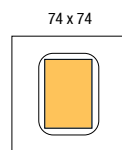

Overall Size	Ioban 2 incise area	Drapes per Box	Boxes per Case
74 cm x 74 cm	33 cm x 43 cm	5	4

- Fluid Collection Pouch

6659 Extra Large Pouch with 3M™ Ioban™ 2 Incise Film

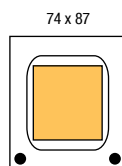

Overall Size	Ioban 2 incise area	Drapes per Box	Boxes per Case
74cm x 87cm	42cm x 52cm	5	4

- 2 Exit Ports

Obstetrics and Gynaecology Drapes

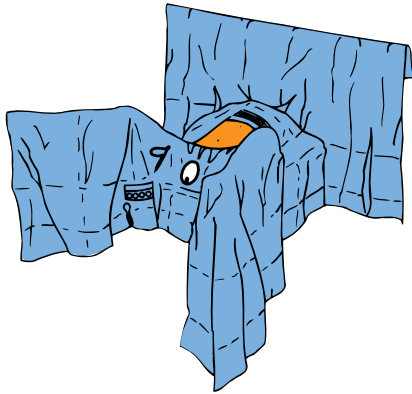

6665 3M™ Ioban™ 2 Abdomino-Perineal Drape - Lithotomy Position

Overall Size	Ioban 2 incise area	Drapes per Box	Boxes per Case
200 cm x 270 cm	35 cm x 46 cm	10	1

- Tube Organisers
- Perineal Adhesive Aperture: 12 cm x 15.5 cm

6665P001 Abdomino-Perineal Draping Pack

Product	Quantity	Overall Size	Packs per Box	Boxes per Case
Abdomino-Perineal Drape	1	200 cm x 270 cm	10	1
Instrument Table Cover	1	100 cm x 150 cm		
Mayo Stand Cover	1	80 cm x 145 cm		
Towel Drape	1	75 cm x 90 cm		
Hand Towels	4	-		

6697 Caesarean Section Drape with 3M™ Ioban™ 2 Incise Pouch

Overall Size	Ioban 2 incise area	Drapes per Box	Boxes per Case
254 cm x 307 cm	30 cm x 30 cm	5	1

- 360-Degree Fluid Collection Pouch
- Tube Organisers

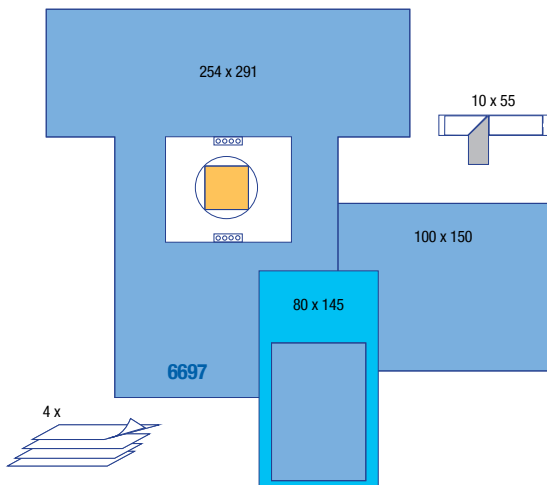

6697P001 Caesarean Section Pack with 3M™ Ioban™ 2 Incise Pouch

Product	Quantity	Overall Size	Packs per Box	Boxes per Case
C-Section Drape	1	254 cm x 307 cm	10	1
Instrument Table Cover	1	100 cm x 150 cm		
Mayo Stand Cover	1	80 cm x 145 cm		
Operation Tape	1	10 cm x 55 cm		
Hand Towels	4	-		

- KEY**
- Repellent Fabric
 - Blue Polyethylene Film
 - Clear Polyethylene Film
 - Absorbent Impervious Fabric
 - Extra Absorbent Material
 - 3M™ Ioban™ Antimicrobial Incise Film
 - 3M™ Steri-Drape™ Incise Film
 - Clear Elastomeric Film
 - Adhesive Area
 - Blue Elastomeric Film

Dimensions are approximate

Obstetrics and Gynaecology Drapes

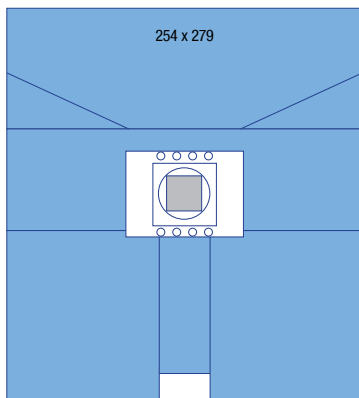

7964 Caesarean Section Drape with 3M™ Steri-Drape™ 2 Incise Pouch-Lithotomy Position

Overall Size	Incise Area	Drapes per Box	Boxes per Case
254 cm x 279 cm	30 cm x 30 cm	5	2

- 360-Degree Fluid Collection Pouch
- Tube Organisers

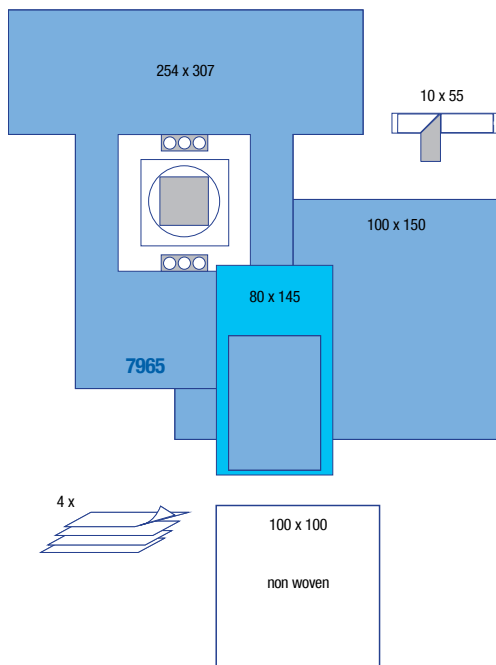

7965 Caesarean Section Drape with 3M™ Steri-Drape™ 2 Incise Pouch

Overall Size	Incise Area	Drapes per Box	Boxes per Case
254 cm x 307 cm	30 cm x 30 cm	5	1

- 360-Degree Fluid Collection Pouch
- Tube Organisers

7965P Caesarean Section Pack with 3M™ Steri-Drape™ 2 Incise Pouch

Product	Quantity	Overall Size	Packs per Box	Boxes per Case
C-Section Drape	1	254 cm x 307 cm	5	2
Instrument Table Cover	1	100 cm x 150 cm		
Mayo Stand Cover	1	80 cm x 145 cm		
Operation Tape	1	10 cm x 55 cm		
Babywrap	1	100 cm x 100 cm		
Hand Towels	4	-		

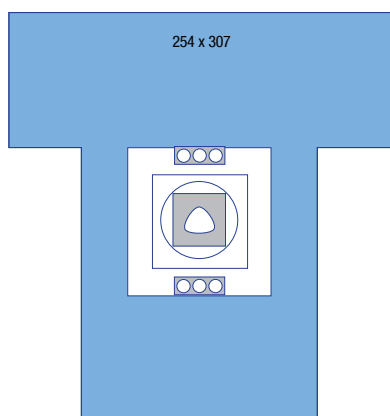

7966 Caesarean Section Drape with Aperture Pouch

Overall Size	Fenestrated Incise Area	Drapes per Box	Boxes per Case
254 cm x 307 cm	30 cm x 30 cm	5	1

- 360-Degree Fluid Collection Pouch
- Tube Organisers

Incise Drapes

General Surgery Drapes / Packs

Orthopaedic Drapes / Packs

Cardiovascular and Cardiac Catheterisation Drapes / Packs

Obstetrics and Gynaecology Drapes / Packs

Urology Drapes / Packs

Ophthalmic Drapes / Packs

Head and Neck Drapes / Packs

Neurosurgery Drapes / Packs

Other Drapes and Accessories

Single Use Gowns – Standard and Reinforced

Custom Packs and Procedure Trays

Cross Reference by Product Number

Cross Reference by Product Name

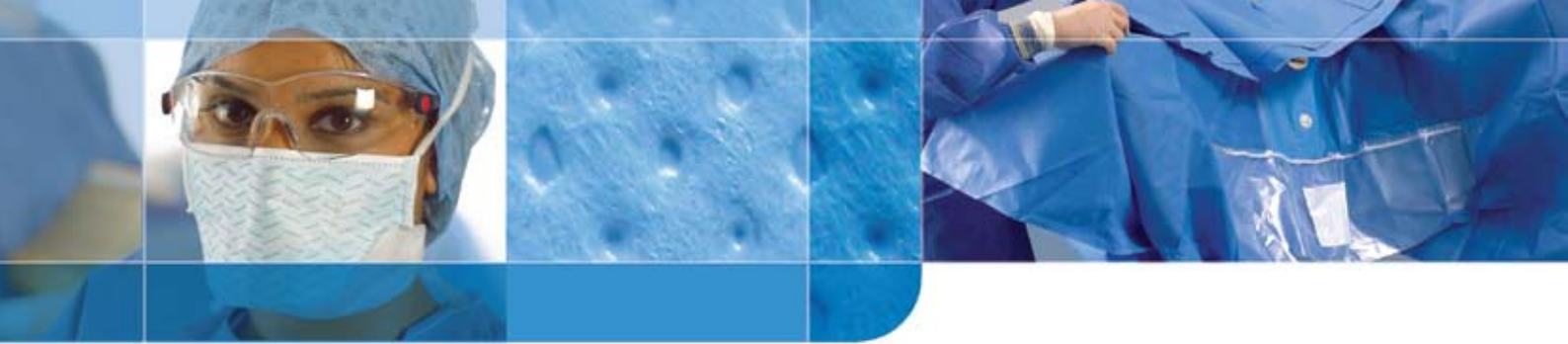

Urology

Large amounts of fluids during urological procedures require drapes that can effectively control this fluid and maintain a safe environment for healthcare workers. Drapes that minimise the amount of preparation time before surgery are an advantage as often there is a quick turnaround time between procedures.

Fluid Control Features

3M surgical drapes effectively control and contain fluid. The absorbent top layer soaks up spills and splatters, keeping fluid off the drape surface while the film part of the material maintains an impervious barrier. Many 3M surgical drapes have fluid collection pouches, which channel and collect body and irrigation fluids.

3M Range

3M surgical drapes are available individually and in specialised packs to cover most surgical procedures. The contents of each draping pack are tailored to match the requirements of each and every procedure. Fully customised packs are also available, to save time and minimise waste.

Impervious to Strikethrough

A drape that allows fluid strikethrough, and thus bacteria transfer, compromises the sterile field, which increases the risk of Surgical Site Infection. That is why a drape that is impervious to liquid is so important.

3M™ loban™ 2 Antimicrobial Incise Drapes

loban 2 antimicrobial incise drapes contain iodophor which is slowly released onto the skin surface giving continuous and controlled antimicrobial activity throughout the surgical procedure. An loban incise area is featured in some speciality drapes. loban incise drapes are also available as separate items.

Reliable Adhesion

3M is a leader in adhesive technology, and has applied this expertise to provide surgical drapes with consistently reliable adhesion to the skin or wound edge. 3M incise drapes adhere securely to wound edges, even during heavy retraction and irrigation, providing a barrier to bacteria on the skin.



Urology Drapes / Packs

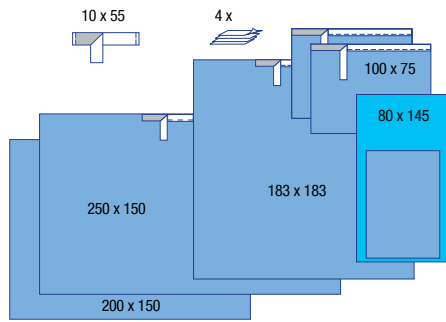

9000 Basic Surgical Pack

Product	Quantity	Overall Size	Packs per Box	Boxes per Case
Operation Tape	1	10 cm x 55 cm	7	2
Hand Towels	4	–		
Mayo Stand Cover	1	80 cm x 145 cm		
Adhesive Towel Drapes	2	100 cm x 75 cm		
Adhesive Drape Sheet (M)	1	183 cm x 183 cm		
Adhesive Drape Sheet (L)	1	250 cm x 150 cm		
Instrument Table Cover	1	200 cm x 150 cm		

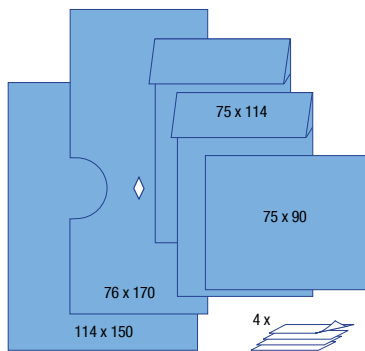

9003 Cystoscopy Surgical Pack

Product	Quantity	Overall Size	Packs per Box	Boxes per Case
Drape Sheet	1	75 cm x 90 cm	10	2
Hand Towels	4	–		
Leggings (pair)	1	75 cm x 114 cm		
Perineal Aperture Drape	1	76 cm x 170 cm		
Instrument Table Cover	1	114 cm x 150 cm		

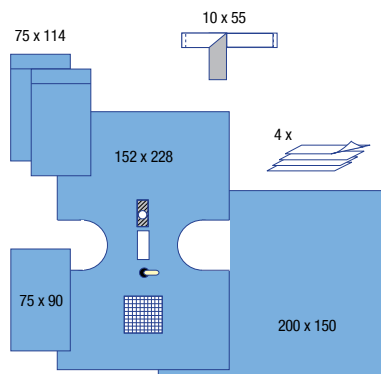

9005 TUR/CYSTO Pack

Product	Quantity	Overall Size	Packs per Box	Boxes per Case
Hand Towels	4	–	6	2
Operation Tape	1	10 cm x 55 cm		
TUR/CYSTO Drape	1	152 cm x 228 cm		
Legging	2	75 cm x 114 cm		
Drape Sheet	1	75 cm x 90 cm		
Instrument Table Cover	1	200 cm x 150 cm		

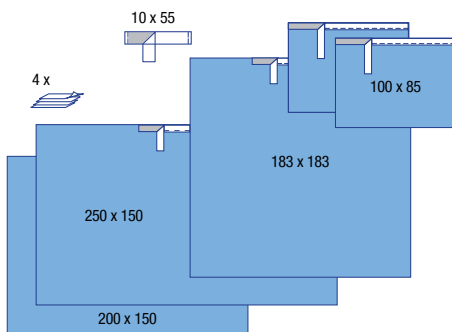

9010 Basic Surgical Pack without Mayo

Product	Quantity	Overall Size	Packs per Box	Boxes per Case
Operation Tape	1	10 cm x 55cm	7	2
Hand Towels	4	–		
Adhesive Towel Drapes	2	100 cm x 85 cm		
Adhesive Drape Sheet (M)	1	183 cm x 183 cm		
Adhesive Drape Sheet (L)	1	250 cm x 150 cm		
Instrument Table Cover	1	200 cm x 150 cm		

KEY	Repellent Fabric	Blue Polyethylene Film
	Extra Absorbent Material	3M™ Ioban™ Antimicrobial Incise Film
	Adhesive Area	Blue Elastomeric Film

Clear Polyethylene Film	Absorbent Impervious Fabric
3M™ Steri-Drape™ Incise Film	Clear Elastomeric Film

Dimensions are approximate

Urology Drapes / Packs

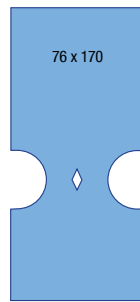

9023 Perineal Aperture Drape

Overall Size	Drapes per Box	Boxes per Case
76 cm x 170 cm	25	4

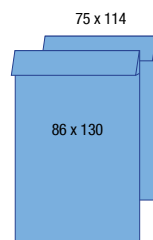

9040 Leggings (pair)

Overall Size	Drapes per Box	Boxes per Case
75 cm x 114 cm	12	4

9040L Leggings Long (pair)

Overall Size	Drapes per Box	Boxes per Case
86 cm x 130 cm	8	4

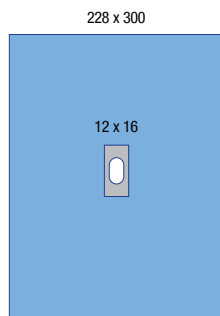

9050 Adhesive Aperture Drape

Overall Size	Adhesive Aperture Size	Drapes per Box	Boxes per Case
228 cm x 300 cm	12 cm x 16 cm	10	2

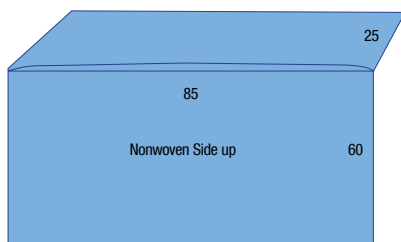

9066 Under Buttock Drape with Cuff

Overall Size	Drapes per Box	Boxes per Case
85 cm x 85 cm	30	4

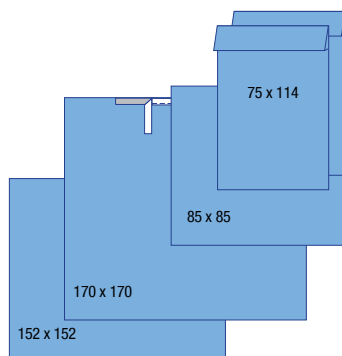

9105 Lithotomy Pack – Under Buttock

Product	Quantity	Overall Size	Packs per Box	Boxes per Case
Under Buttocks Drape with Cuff	1	85 cm x 85 cm	7	2
Leggings	2	75 cm x 114 cm		
Adhesive Drape Sheet	1	170 cm x 170 cm		
Back Table Cover	1	152 cm x 152 cm		

Urology Drapes / Packs

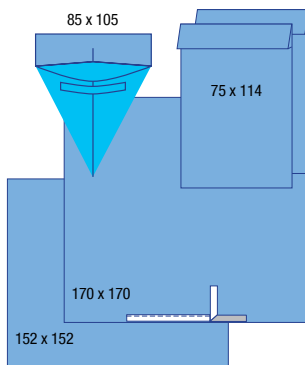

9106 Lithotomy Pack – with Pouch

Product	Quantity	Overall Size	Packs per Box	Boxes per Case
Under Buttocks Drape with Pouch	1	85 cm x 105 cm	7	2
Leggings	2	75 cm x 114 cm		
Adhesive Drape Sheet	1	170 cm x 170 cm		
Back Table Cover	1	152 cm x 152 cm		

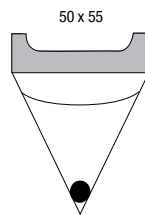

1016 Irrigation Pouch

Overall Size	Units per Box	Boxes per Case
50 cm x 55 cm	10	4

- Adhesive Strip
- 1 Exit Port

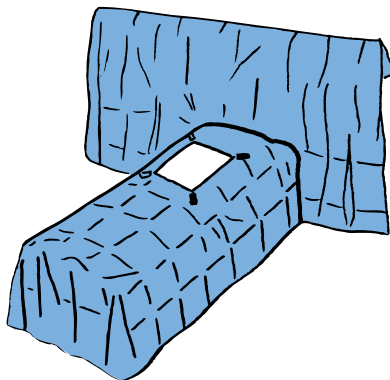

1031 Laparoscopic Drape - Supine Position

Overall Size	Adhesive Aperture Size	Drapes per Box	Boxes per Case
285 cm x 182 cm	27 cm x 30 cm	10	2

- Available as a single box
- 4 Tube Organisers (ref. 1115)

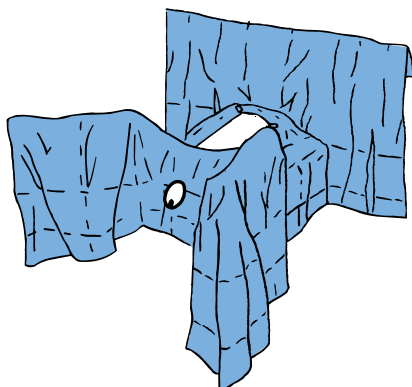

1032 Laparoscopic Drape - Lithotomy Position

Overall Size	Adhesive Aperture Size	Drapes per Box	Boxes per Case
241 cm x 228 cm	27 cm x 30 cm	8	2

- 4 Tube Organisers (ref. 1115)
- Perineal Adhesive Aperture: 12 cm x 15.5 cm
- Available as a single box

1032P Laparoscopic Drape Pack / Lithotomy Position

Product	Quantity	Overall Size	Packs per Box	Boxes per Case
Laparoscopy Drape	1	241 cm x 228 cm	5	2
Instrument Table Cover		200 cm x 150 cm		
Hand Towels	4	-		
Mayo Stand Cover	1	80 cm x 145 cm		

KEY	Repellent Fabric	Blue Polyethylene Film	3M™ Ioban™ Antimicrobial Incise Film

	Clear Polyethylene Film		Absorbent Impervious Fabric
	3M™ Steri-Drape™ Incise Film		Clear Elastomeric Film

Dimensions are approximate

Urology Drapes / Packs

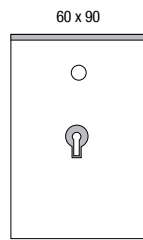

1071 Urological Sheet

Overall Size	Aperture Size	Drapes per Box	Boxes per Case
60cm x 90cm	5cm	10	4

- Neoprene Finger Cot with Adhesive
- Adhesive Strip

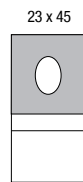

1072 Aperture Pouch Drape

Overall Size	Adhesive Size	Oval Aperture Size	Drapes per Box	Boxes per Case
23 cm x 45 cm	23 cm x 25 cm	11 cm x 8.5 cm	10	4

- Pouch Size: 15.5 cm x 23 cm

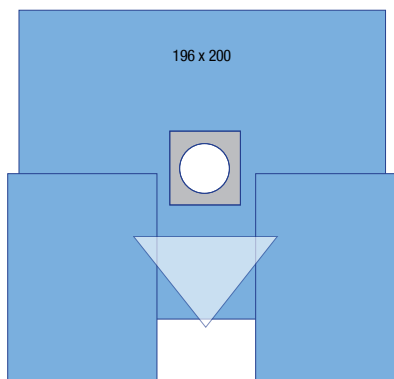

1078 Perineal Drape with Pouch

Overall Size	Drapes per Box	Boxes per Case
196 cm x 200 cm	10	2

- Elastic Aperture
- Neoprene Finger Cot
- Large Integrated Fluid Collection Pouch with Filter and Exit Port

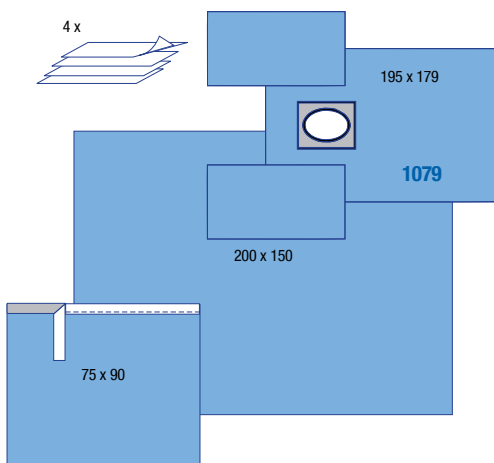

1079 Gynaecological Drape

Overall Size	Adhesive Aperture Size	Drapes per Box	Boxes per Case
195 cm x 179 cm	12 cm x 9 cm	14	2

- Available as a single box

1079P Gynaecological Pack

Product	Quantity	Overall Size	Packs per Box	Boxes per Case
Gynaecology Drape	1	195 cm x 179 cm	7	2
Instrument Table Cover	1	100 cm x 150 cm		
Towel Drape	1	75 cm x 90 cm		

Urology Drapes / Packs

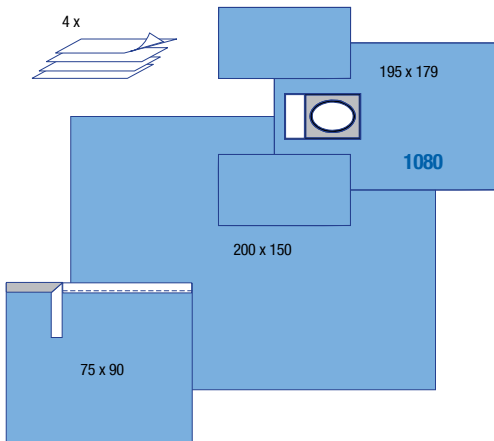

1080 Gynaecological Drape with 1072 Pouch

Overall Size	Adhesive Aperture Size	Drapes per Box	Boxes per Case
195 cm x 179 cm	12 cm x 9 cm	7	2

- Available as a single box

1080P Gynaecological Pack with 1072 Pouch

Product	Quantity	Overall Size	Packs per Box	Boxes per Case
Gynaecology Drape	1	195 cm x 179 cm	7	2
Instrument Table Cover	1	200 cm x 150 cm		
Towel Drape	1	75 cm x 90 cm		

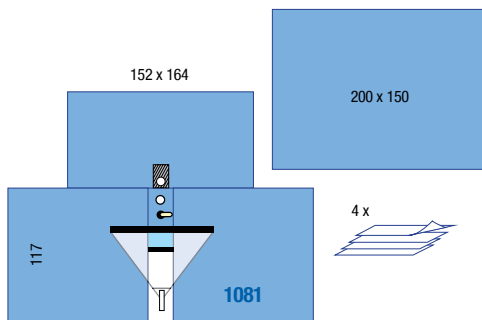

1081 TUR/Urological Drape

Overall Size	Abdominal Adhesive Aperture Size	Drapes per Box	Boxes per Case
152 cm x 164 cm	6 cm	14	2

- Elastic Aperture
- Neoprene Finger Cot
- Large Integrated Fluid Collection Pouch with Filter and Exit Ports

1081P TUR Pack

Product	Quantity	Overall Size	Packs per Box	Boxes per Case
TUR Drape	1	152 cm x 164 cm	7	2
Instrument Table Cover	1	100 cm x 150 cm		
Hand Towels	4	-		

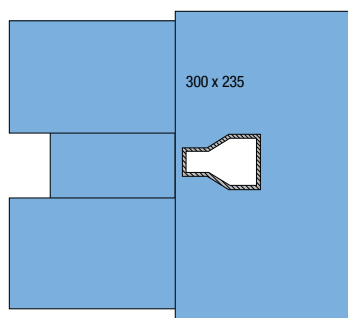

1082 TVT/TOT Drape

Overall Size	Aperture Size	Drapes per Box	Boxes per Case
235 cm x 300 cm	11 cm x 8.5 cm	10	4

- Pouch Size: 15.5cm x 23cm

KEY	Repellent Fabric	Blue Polyethylene Film	Clear Polyethylene Film	Absorbent Impervious Fabric
	Extra Absorbent Material	3M™ Ioban™ Antimicrobial Incise Film	3M™ Steri-Drape™ Incise Film	Clear Elastomeric Film
	Adhesive Area	Blue Elastomeric Film		

Dimensions are approximate

Urology Drapes / Packs

2065 Abdomino-Perineal Drape-Lithotomy Position

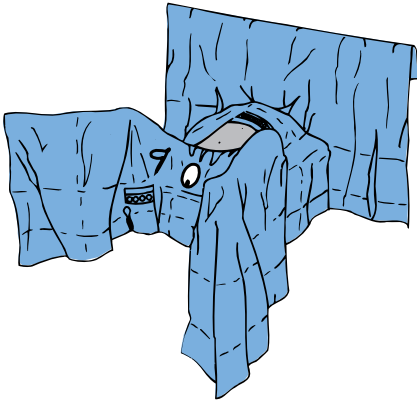

Overall Size	3M™ Steri-Drape™ 2 Incise Area	Drapes per Box	Boxes per Case
195 cm x 271 cm	41 cm x 45 cm	8	1

- Tube Organisers
- Perineal Adhesive Aperture: 12cm x 15.5cm

2065P Abdomino-Perineal Draping Pack

Product	Quantity	Overall Size	Packs per Box	Boxes per Case
Abdomino-Perineal Drape	1	195 cm x 271 cm	10	1
Instrument Table Cover	1	100 cm x 150 cm		
Mayo Stand Cover	1	80 cm x 145 cm		
Towel Drape	1	75 cm x 90 cm		
Hand Towels	4	-		

6665 3M™ Ioban™ 2 Abdomino-Perineal Drape - Lithotomy Position

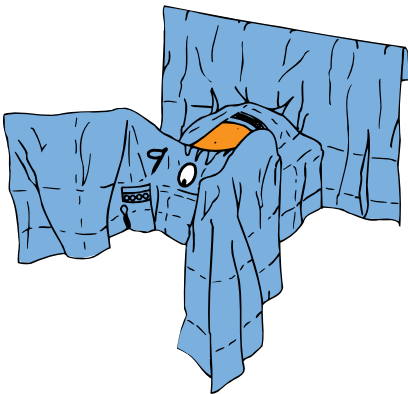

Overall Size	Ioban 2 incise area	Drapes per Box	Boxes per Case
200 cm x 270 cm	35 cm x 46 cm	10	1

- Tube Organisers
- Perineal Adhesive Aperture: 12 cm x 15.5 cm

6665P001 Abdomino-Perineal Draping Pack

Product	Quantity	Overall Size	Packs per Box	Boxes per Case
Abdomino-Perineal Drape	1	200 cm x 270 cm	10	1
Instrument Table Cover	1	100 cm x 150 cm		
Mayo Stand Cover	1	80 cm x 145 cm		
Towel Drape	1	75 cm x 90 cm		
Hand Towels	4	-		

Incise Drapes

General Surgery Drapes / Packs

Orthopaedic Drapes / Packs

Cardiovascular and Cardiac Catheterisation Drapes / Packs

Obstetrics and Gynaecology Drapes / Packs

Urology Drapes / Packs

Ophthalmic Drapes / Packs

Head and Neck Drapes / Packs

Neurosurgery Drapes / Packs

Other Drapes and Accessories

Single Use Gowns – Standard and Reinforced

Custom Packs and Procedure Trays

Cross Reference by Product Number

Cross Reference by Product Name



Ophthalmic

Ophthalmic procedures are often carried out under local anaesthesia and therefore the drapes used need to be lightweight and comfortable for the patient. 3M ophthalmic drapes are made from a lightweight and breathable material that allows fluid to run away from the operative site into specifically designed fluid collection pouches, ensuring the drapes remain dry and the patient is comfortable.

Fluid Control Features

3M surgical drapes effectively control and contain fluid. This not only reduces potential exposure to infectious body fluids, but keeps the patient dry which can help reduce turnaround time between procedures.

3M Range

3M surgical drapes are available individually and in specialised packs to cover most surgical procedures. The contents of each draping pack are tailored to match the requirements of each and every procedure. Fully customised packs are also available, to save time and minimise waste.



Ophthalmic Drapes / Packs

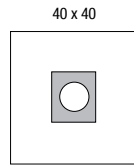

1020 Small Drape with Adhesive Aperture

Overall Size	Adhesive Size	Drapes per Box	Boxes per Case
40 cm x 40 cm	9.9 cm x 12.5 cm	10	4

- Circular Aperture Size: 6.3 cm

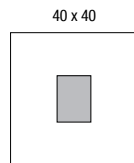

1021 Small Drape with Incise Film

Overall Size	3M™ Steri-Drape™ Incise Area	Drapes per Box	Boxes per Case
40 cm x 40 cm	9.9 cm x 12.5 cm	10	4

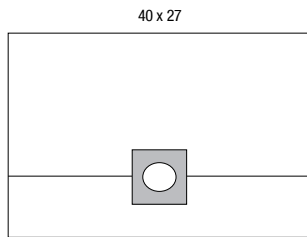

1022 Refractive Drape

Overall Size	Adhesive Size	Oval Aperture Size	Drapes per Box	Boxes per Case
40 cm x 27 cm	7.2 cm x 7.2 cm	4.4 cm x 3.8 cm	20	4

- Clear Plastic

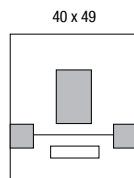

1023 Small Drape with Incise Film and Pouch

Overall Size	Steri-Drape incise area	Drapes per Box	Boxes per Case
40 cm x 49 cm	12.5 cm x 10 cm	10	4

- 2 Adhesive Patches
- Fluid Collection Pouch

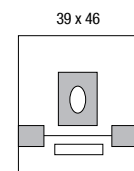

1024 Small Drape with Adhesive Aperture and Pouch

Overall Size	Adhesive Size	Oval Aperture Size	Drapes per Box	Boxes per Case
39 cm x 46 cm	12.5 cm x 10 cm	3.8 cm x 6.3 cm	10	4

- 2 Adhesive Patches
- Fluid Collection Pouch

KEY	Repellent Fabric	Blue Polyethylene Film	Clear Polyethylene Film	Absorbent Impervious Fabric
	Extra Absorbent Material	3M™ Ioban™ Antimicrobial Incise Film	3M™ Steri-Drape™ Incise Film	Clear Elastomeric Film
	Adhesive Area	Blue Elastomeric Film	Dimensions are approximate	

Ophthalmic Drapes / Packs

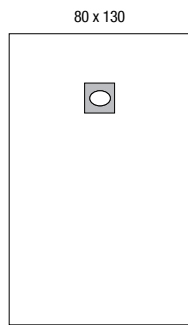

1030 Medium Drape with Adhesive Aperture

Overall Size	Adhesive Size	Oval Aperture Size	Drapes per Box	Boxes per Case
80 cm x 130 cm	10 cm x 12.5 cm	5.1 cm x 7.4 cm	10	4

- Clear Plastic

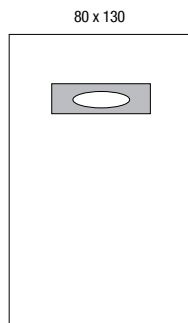

1033 Medium Drape with Wide Adhesive Aperture

Overall Size	Adhesive Size	Oval Aperture Size	Drapes per Box	Boxes per Case
80 cm x 130 cm	23 cm x 11.5 cm	15 cm x 6 cm	10	4

- Clear Plastic

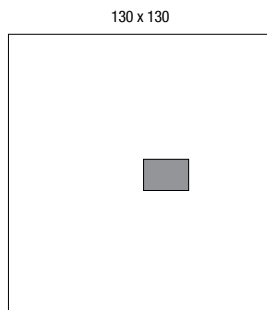

1060 Medium Drape with Incise Film

Overall Size	3M™ Steri-Drape™ Incise Area	Drapes per Box	Boxes per Case
130 cm x 130 cm	10 cm x 12.5 cm	10	4

- Clear Plastic

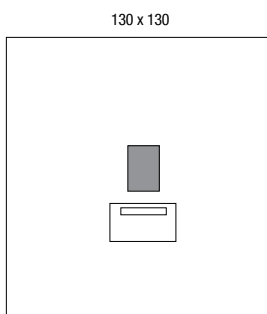

1061 Medium Drape with Incise Film and Pouch

Overall Size	Steri-Drape incise area	Drapes per Box	Boxes per Case
130 cm x 130 cm	10 cm x 12.5 cm	10	4

- Fluid Collection Pouch
- Clear Plastic

Ophthalmic Drapes / Packs

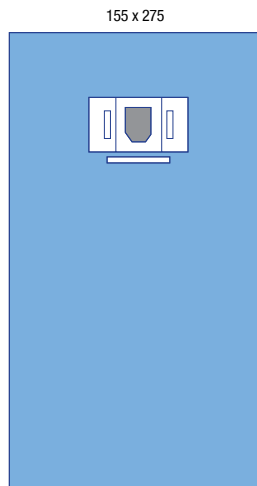

1055B Large Ophthalmic Drape with Incise Film and Pouches

Overall Size	3M™ Steri-Drape™ Incise Area	Drapes per Box	Boxes per Case
155 cm x 275 cm	12 cm x 9 cm	14	2

- 2 Fluid Collection Pouches
- Face Arch
- Repellent Fabric

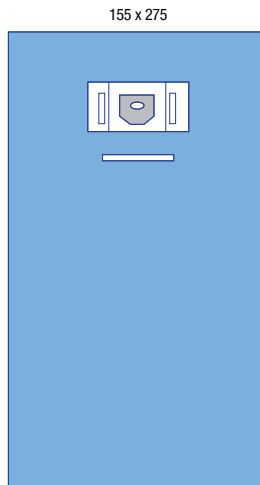

1065B Large Ophthalmic Sheet with Aperture and Pouches

Overall Size	Adhesive Size	Oval Aperture Size	Drapes per Box	Boxes per Case
155 cm x 275 cm	12 cm x 9 cm	6 cm x 3 cm	14	2

- 2 Fluid Collection Pouches
- Face Arch
- Repellent Fabric

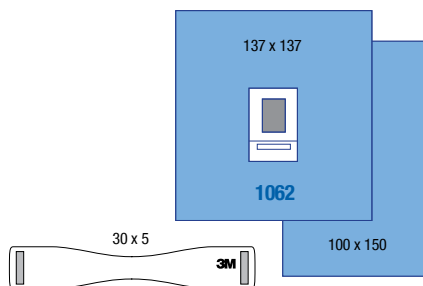

1062 Ophthalmic Drape with Incise Film and Pouch

Overall Size	Steri-Drape incise area	Drapes per Box	Boxes per Case
137 cm x 137 cm	8 cm x 10 cm	30	2

- Fluid Collection Pouch
- Repellent Fabric

1062P001 Ophthalmology Pack

Product	Quantity	Overall Size	Packs per Box	Boxes per Case
Ophthalmology Drape	1	137 cm x 137 cm	18	1
Instrument Table Cover	1	100 cm x 150 cm		
Patient Face Protector	1	30 cm		

- KEY**
- Repellent Fabric
 - Blue Polyethylene Film
 - Clear Polyethylene Film
 - Absorbent Impervious Fabric
 - Extra Absorbent Material
 - 3M™ Ioban™ Antimicrobial Incise Film
 - 3M™ Steri-Drape™ Incise Film
 - Clear Elastomeric Film
 - Adhesive Area
 - Blue Elastomeric Film

Dimensions are approximate

Ophthalmic Drapes / Packs

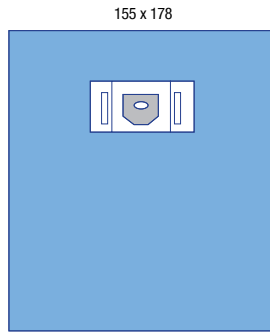

1064 Ophthalmic Sheet with Aperture and Pouches

Overall Size	Adhesive Size	Oval Aperture Size	Drapes per Box	Boxes per Case
155 cm x 178 cm	12 cm x 9 cm	6 cm x 3 cm	20	2

- 2 Fluid Collection Pouches
- Repellent Fabric

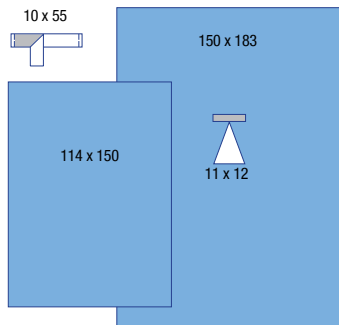

9019 Oral Pack

Product	Quantity	Overall Size	Packs per Box	Boxes per Case
Operation Tape	1	10 cm x 55 cm	16	2
Adhesive Aperture Drape	1	150 cm x 183 cm		
Non Adhesive Drape Sheet	1	114 cm x 150 cm		

Incise Drapes

General Surgery Drapes / Packs

Orthopaedic Drapes / Packs

Cardiovascular and Cardiac Catheterisation Drapes / Packs

Obstetrics and Gynaecology Drapes / Packs

Urology Drapes / Packs

Ophthalmic Drapes / Packs

Head and Neck Drapes / Packs

Neurosurgery Drapes / Packs

Other Drapes and Accessories

Single Use Gowns – Standard and Reinforced

Custom Packs and Procedure Trays

Cross Reference by Product Number

Cross Reference by Product Name



Head and Neck

Head and neck surgery procedures pose a number of challenges for a draping system. Procedures on the ears, nose and throat can be difficult to drape and therefore require a versatile but comfortable range. Specific needs of some procedures will require speciality drapes, with reliable adhesion and fluid control features.

Impervious to Strikethrough

Fluid transfer and therefore bacterial transfer, compromises the sterile field, which increases the risk of a surgical site infection. 3M's range of surgical drapes is impervious to liquid strikethrough which can help to reduce bacterial transfer.

Absorbent Fabric and Fluid Control Features

Reducing fluid contamination during a procedure not only decreases potential exposure to infectious fluids, but can keep the patient dry which may decrease turn-around time. Many 3M drapes have fluid collection pouches and the 3M™ Steri-Drape™ 9000 Drapes range is absorbent, which can reduce fluid contamination.

Superior Strength and Comfort

Ensuring a surgical drape is robust enough to withstand the most arduous procedures can be paramount to reducing the risk of a surgical site infection.

In line with EN 13795 sterile drapes should be able to withstand physical conditions; resist tears and conform to the patient and equipment.

The material of the Steri-Drape 9000 drapes range is strong enough to withstand these demands and even the heaviest surgical instruments can be placed upon them without concern. In addition the material's design makes it highly conformable with patient and equipment contours.



Head and Neck Drapes / Packs

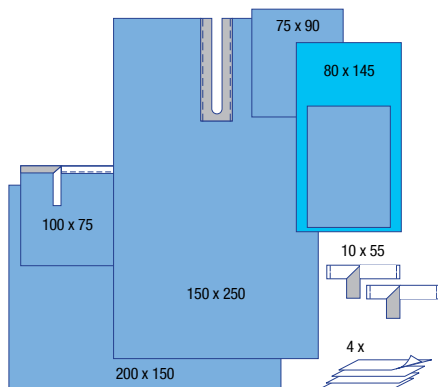

9007 ENT Surgical Pack

Product	Quantity	Overall Size	Packs per Box	Boxes per Case
Operation Tapes	2	10 cm x 55cm	8	2
Hand Towels	4	–		
Mayo Stand Cover	1	80 cm x 145 cm		
Drape Sheet	1	75 cm x 90 cm		
Adhesive Split Sheet	1	150 cm x 250 cm		
Adhesive Towel Drape	1	100 cm x 75 cm		
Instrument Table Cover	1	150 cm x 150 cm		

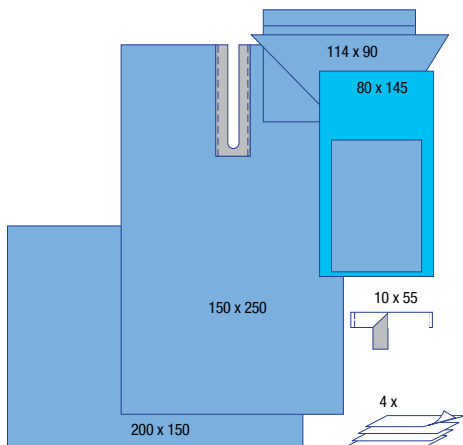

9008 Head and Neck Pack

Product	Quantity	Overall Size	Packs per Box	Boxes per Case
Operation Tape	1	10 cm x 55 cm	7	2
Hand Towels	4	–		
Mayo Stand Cover	1	80 cm x 145 cm		
Headwrap	1	114 cm x 90 cm		
Adhesive Split Sheet	1	150 cm x 250 cm		
Instrument Table Cover	1	200 cm x 150 cm		

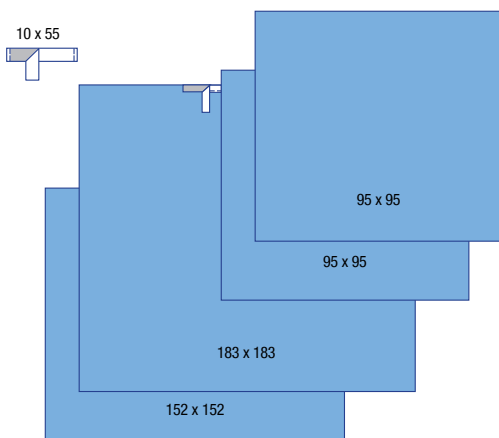

9009 Basic Head and Neck Pack

Product	Quantity	Overall Size	Packs per Box	Boxes per Case
Operation Tape	1	10 cm x 55 cm	10	2
Non Adhesive Drape Sheet	2	95 cm x 95 cm		
Adhesive Drape Sheet	1	183 cm x 183 cm		
Back Table Cover	1	152 cm x 152 cm		

KEY	Repellent Fabric	Blue Polyethylene Film	Clear Polyethylene Film	Absorbent Impervious Fabric
	Extra Absorbent Material	3M™ Ioban™ Antimicrobial Incise Film	3M™ Steri-Drape™ Incise Film	Clear Elastomeric Film
	Adhesive Area	Blue Elastomeric Film		

Dimensions are approximate

Head and Neck Drapes / Packs

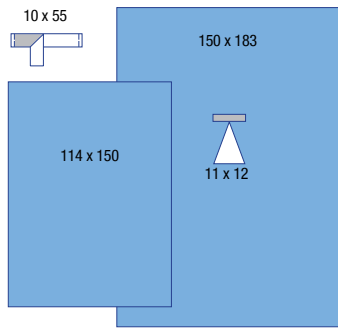

9019 Oral Pack

Product	Quantity	Overall Size	Packs per Box	Boxes per Case
Operation Tape	1	10 cm x 15 cm	16	2
Adhesive Aperture Drape	1	150 cm x 183 cm		
Non Adhesive Drape Sheet	1	114 cm x 150 cm		

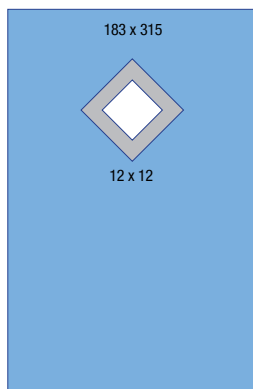

9051 Thyroid Drape

Overall Size	Adhesive Aperture Size	Drapes per Box	Boxes per Case
183 cm x 315 cm	12 cm x 12 cm	15	2

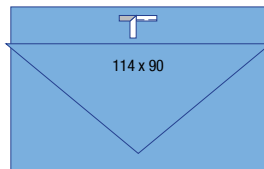

9070 Turban Drape Sheet

Overall Size	Item per Box	Boxes per Case
114 cm x 90 cm	22	4

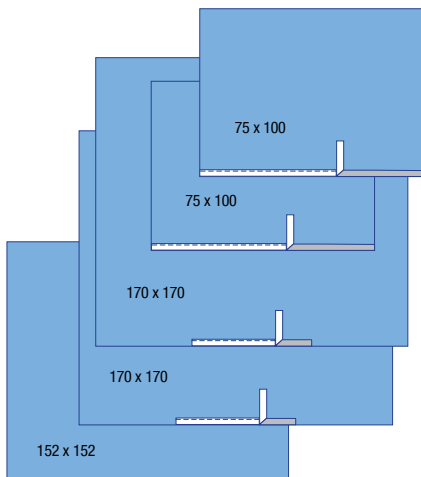

9100 General Pack

Product	Quantity	Overall Size	Packs per Box	Boxes per Case
Adhesive Side Towel	2	100 cm x 75 cm	7	2
Adhesive Drape Sheet	2	170 cm x 170 cm		
Back Table Cover	1	152 cm x 152 cm		

Incise Drapes

General Surgery Drapes / Packs

Orthopaedic Drapes / Packs

Cardiovascular and Cardiac Catheterisation Drapes / Packs

Obstetrics and Gynaecology Drapes / Packs

Urology Drapes / Packs

Ophthalmic Drapes / Packs

Head and Neck Drapes / Packs

Neurosurgery Drapes / Packs

Other Drapes and Accessories

Single Use Gowns – Standard and Reinforced

Custom Packs and Procedure Trays

Cross Reference by Product Number

Cross Reference by Product Name



Neurosurgery

Neurosurgical procedures are often lengthy and involve large amounts of blood and irrigation fluids. Drapes that can adequately collect this fluid and maintain a safe environment for healthcare workers are an advantage and will ensure the risk of infection is also reduced. Ease of application is also imperative as these procedures are often emergencies.

Superior Strength and Comfort

The material of the Steri-Drape range of surgical drapes is strong enough to withstand the most arduous procedures and manipulation. They are soft and pliable for easy application.

Reliable Adhesion

3M is a leader in adhesive technology, and has applied this expertise to provide surgical drapes with consistently reliable adhesion to the skin or wound edge. 3M incise drapes adhere securely to wound edges, even during heavy retraction and irrigation, providing a barrier to bacteria on the skin.

Fluid Control Features

3M surgical drapes effectively control and contain fluid. The absorbent top layer soaks up spills and splatters, keeping fluid off the drape surface while the film part of the material maintains an impervious barrier. Many 3M surgical drapes have fluid collection pouches, which channel and collect body and irrigation fluids.

3M™ Ioban™ 2 Antimicrobial Incise Drapes

Ioban 2 antimicrobial incise drapes contain iodophor which is slowly released onto the skin surface giving continuous and controlled antimicrobial activity throughout the surgical procedure. An Ioban incise area is featured in some speciality drapes. Ioban incise drapes are also available as separate items.

Impervious to Strikethrough

A drape that allows fluid strikethrough, and thus bacteria transfer, compromises the sterile field, which increases the risk of Surgical Site Infection. That is why a drape that is impervious to liquid is so important.



Neurosurgery Drapes / Packs

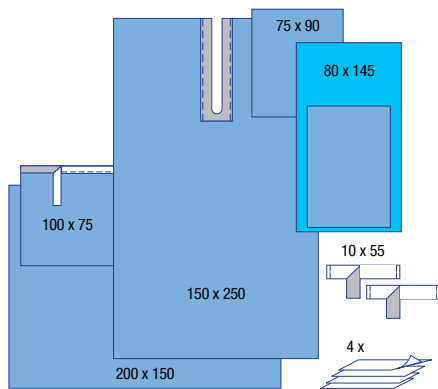

9007 ENT Surgical Pack

Product	Quantity	Overall Size	Packs per Box	Boxes per Case
Operation Tapes	2	10 cm x 55 cm	8	2
Hand Towels	4	–		
Mayo Stand Cover	1	80 cm x 145 cm		
Drape Sheet	1	75 cm x 90 cm		
Adhesive Split Sheet	1	150 cm x 250 cm		
Adhesive Towel Drape	1	100 cm x 75 cm		
Instrument Table Cover	1	150 cm x 150 cm		

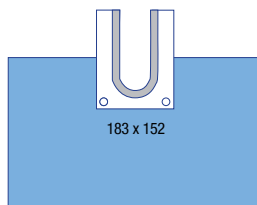

9047 Neuro Split Sheet with Pouch

Overall Size	Adhesive Split Size	Drapes per Box	Boxes per C
183 cm x 152 cm	16 cm x 40 cm	15	2

- Fluid Collection Pouch
- 2 Exit Ports

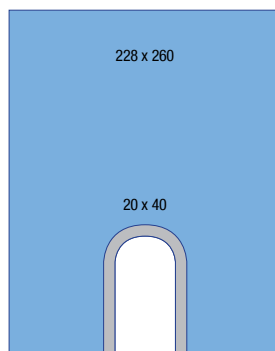

9048 Split Sheet

Overall Size	Adhesive Split Size	Drapes per Box	Boxes per C
228 cm x 260 cm	20 cm x 40 cm	15	2

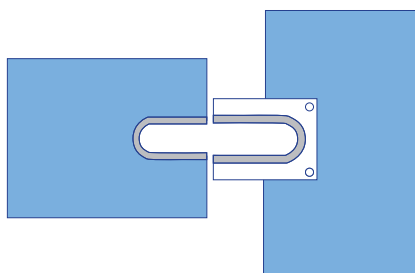

The 9047 and the 9048 (Split Sheet) will together create a Neuro Drape

KEY	Repellent Fabric	Blue Polyethylene Film	Clear Polyethylene Film	Absorbent Impervious Fabric
	Extra Absorbent Material	3M™ Ioban™ Antimicrobial Incise Film	3M™ Steri-Drape™ Incise Film	Clear Elastomeric Film
	Adhesive Area	Blue Elastomeric Film		

Dimensions are approximate

Neurosurgery Drapes / Packs

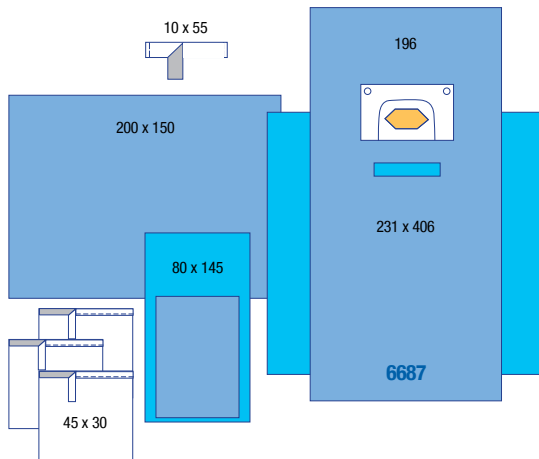

6687 Craniotomy Drape with 3M™ Ioban™ 2 Incise Film

Overall Size	Incise Area	Drapes per Box	Boxes per Case
231 cm x 406 cm	24 cm x 37cm	10	1

- U shaped pouch with exit ports

6687P Craniotomy Pack with 3M™ Ioban™ 2 Incise Film

Product	Quantity	Overall Size	Packs per Box	Boxes per Case
Craniotomy Drape	1	196 cm x 406 cm	7	1
Operation Tape	1	10 cm x 55 cm		
Adhesive Towel Drape	3	45 cm x 30 cm		
Mayo Stand Cover	1	100 cm x 145 cm		
Instrument Table Cover	1	200 cm x 150 cm		

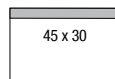

1000 Small Towel Drape

Overall Size	Adhesive Strip Width	Drapes per Box	Boxes per Case
45 cm x 30 cm	3 cm	10	4

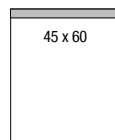

1010 Large Towel Drape

Overall Size	Adhesive Strip Width	Drapes per Box	Boxes per Case
45 cm x 60 cm	3 cm	10	4

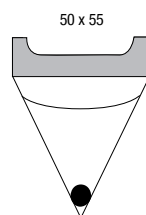

1016 Irrigation Pouch

Overall Size	Drapes per Box	Boxes per Case
50 cm x 55 cm	10	4

Incise Drapes

General Surgery Drapes / Packs

Orthopaedic Drapes / Packs

Cardiovascular and Cardiac Catheterisation Drapes / Packs

Obstetrics and Gynaecology Drapes / Packs

Urology Drapes / Packs

Ophthalmic Drapes / Packs

Head and Neck Drapes / Packs

Neurosurgery Drapes / Packs

Other Drapes and Accessories

Single Use Gowns – Standard and Reinforced

Custom Packs and Procedure Trays

Cross Reference by Product Number

Cross Reference by Product Name

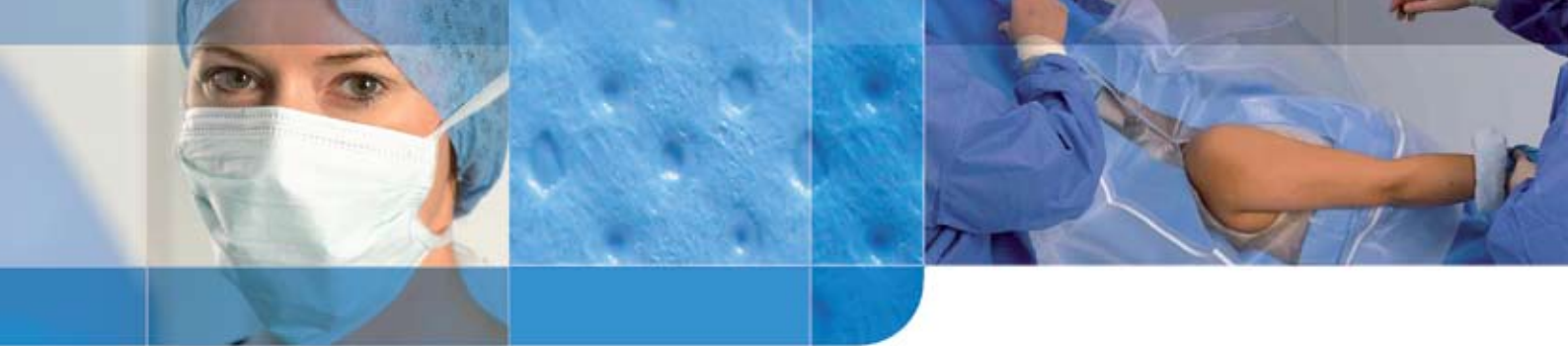

Other drapes and accessories

Whatever your draping requirements, 3M can supply an additional range of accessories to complement the speciality drapes and drape packs available.

The range of adhesive and non-adhesive individually packed drapes combines the benefits of absorbent, impervious fabric and the flexibility of cost effective draping options.

In addition, the range of plastic drapes and equipment covers meets the majority of surgical procedural needs.



Fabric Drapes

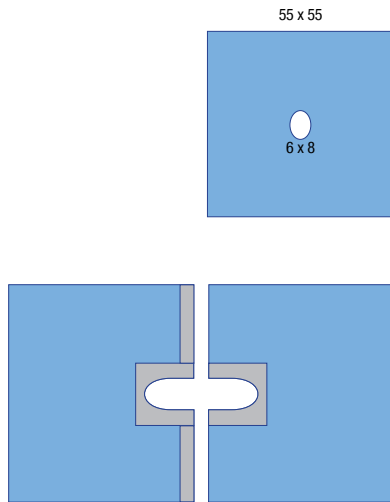

55 x 55

6 x 8

9026 Aperture Drape

Overall Size	Drapes per Box	Boxes per Case
55 cm x 55 cm	100	4

9027 Adjustable Aperture Drape

Product	Quantity	Overall Size	Packs per Box	Boxes per Case
Two piece Adjustable Aperture Drape	1	70 cm x 50 cm	40	4

9027L Adjustable Aperture Drape (Long)

Product	Quantity	Overall Size	Packs per Box	Boxes per Case
Two piece Adjustable Aperture Drape	1	100 cm x 150 cm	25	4

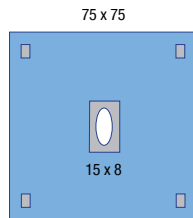

75 x 75

15 x 8

9029 Adhesive Aperture Drape

Overall Size	Drapes per Box	Boxes per Case
75 cm x 75 cm	40	4

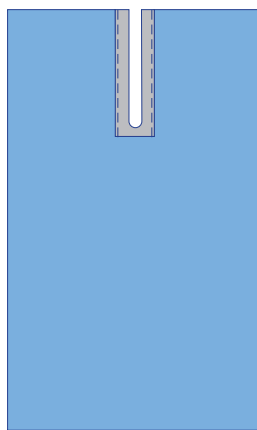

Adhesive Split Sheets

	Overall Size	Drapes per Box	Boxes per Case
9043 Split Size 7 x 70cm	150 cm x 183 cm	30	2
9044 Split Size 7 x 70cm	150 cm x 250 cm	25	2
9045 Split Size 20 x 100cm	228 cm x 260 cm	15	2
9048 Split Size: 20 x 40	228 cm x 260 cm	15	2

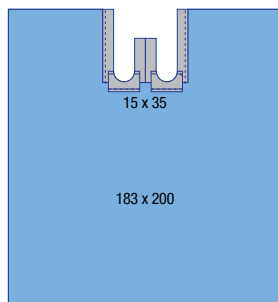

9046 Bilateral Split Sheet

Overall Size	Aperture Split	Drapes per Box	Boxes per Case
183 cm x 200 cm	15 cm x 35 cm	15	2

KEY	Repellent Fabric	Blue Polyethylene Film	Clear Polyethylene Film	Absorbent Impervious Fabric
	Extra Absorbent Material	3M™ Ioban™ Antimicrobial Incise Film	3M™ Steri-Drape™ Incise Film	Clear Elastomeric Film
	Adhesive Area	Blue Elastomeric Film		

Dimensions are approximate

Fabric Drapes



Adhesive Aperture Drapes

	Overall Size	Drapes per Box	Boxes per Case
Centred Aperture 9028	75 cm x 75 cm	40	4
9030	120 cm x 150 cm	20	4
Off-Centre Aperture 9031	150 cm x 183 cm	25	2

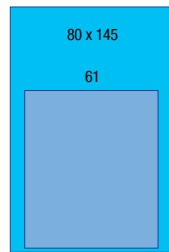

9035 Mayo Stand Cover

Overall Size	Drapes per Box	Boxes per Case
80 cm x 145 cm	40	2

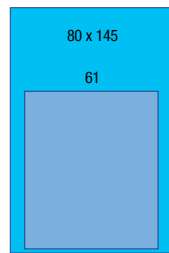

9039E Reinforced Mayo Stand Cover

Overall Size	Drapes per Box	Boxes per Case
80 cm x 145 cm	20	2

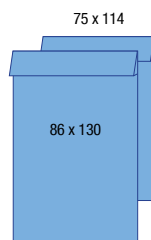

9040 Leggings (pair)

Overall Size	Drapes per Box	Boxes per Case
75 cm x 114 cm	12	4

9040L Leggings Long (pair)

Overall Size	Drapes per Box	Boxes per Case
86 cm x 130 cm	8	4

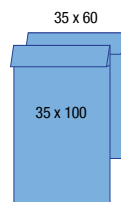

Leggings

	Overall Size	Drapes per Box	Boxes per Case
9041	35 cm x 60 cm	50	4
9042	35 cm x 100 cm	35	4

Fabric Drapes

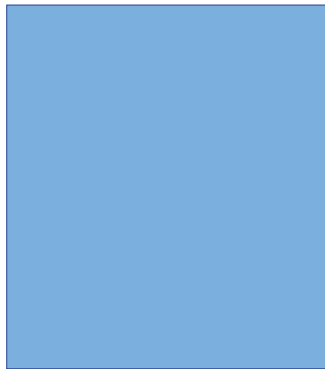

Non-Adhesive Drape Sheets/Instrument Table Covers

	Overall Size	Drapes per Box	Boxes per Case
9067	37 cm x 45 cm	150	4
9069	5 cm x 90 cm	30	4
9071	97 cm x 97 cm	40	4
9072	100 cm x 150 cm	30	2
9074	150 cm x 150 cm	12	4
9075	150 cm x 170 cm	15	2
9077	200 cm x 150 cm	15	2
9077R	200 cm x 150 cm	24	2
9079	200 cm x 228 cm	20	2

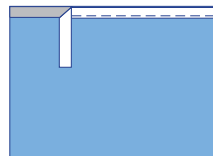

Adhesive Towel Drapes

	Overall Size	Drapes per Box	Boxes per Case
9084	75 cm x 75 cm	40	4
9085	100 cm x 85 cm	30	4
9086	100 cm x 75 cm	40	4

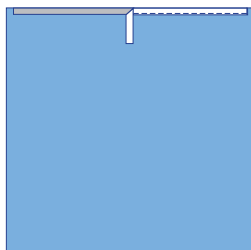

Adhesive Drape Sheets

	Overall Size	Drapes per Box	Boxes per Case
9087	183 cm x 183 cm	25	2
9088	250 cm x 150 cm	25	2
9089	170 cm x 170 cm	22	2
9090	300 cm x 228 cm	12	2

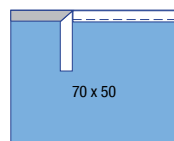

9095 Absorbent Pad

Overall Size	Items per Box	Boxes per Case
70 cm x 50 cm	50	4

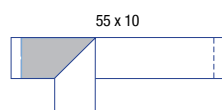

9099 Operation Tape

Overall Size	Items per Box	Boxes per Case
10 cm x 55 cm	250	2

- KEY**
- Repellent Fabric
 - Blue Polyethylene Film
 - Clear Polyethylene Film
 - Absorbent Impervious Fabric
 - Extra Absorbent Material
 - 3M™ Ioban™ Antimicrobial Incise Film
 - 3M™ Steri-Drape™ Incise Film
 - Clear Elastomeric Film
 - Adhesive Area
 - Blue Elastomeric Film

Dimensions are approximate

Clear Plastic Drapes

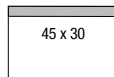

1000 Small Towel Drape

Overall Size	Adhesive Strip Width	Drapes per Box	Boxes per Case
45 cm x 30 cm	3 cm	10	4

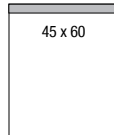

1010 Large Towel Drape

Overall Size	Adhesive Strip Width	Drapes per Box	Boxes per Case
45 cm x 60 cm	3 cm	10	4

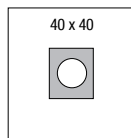

1020 Small Drape with Adhesive Aperture

Overall Size	Adhesive Size	Drapes per Box	Boxes per Case
40 cm x 40 cm	9.9 cm x 12.5 cm	10	4

- Aperture Size: 6.3cm

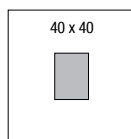

1021 Small Drape with Incise Film

Overall Size	3M™ Steri-Drape™ Incise Area	Drapes per Box	Boxes per Case
40 cm x 40 cm	9.9 cm x 12.5 cm	10	4

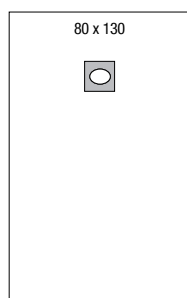

1030 Medium Drape with Adhesive Aperture

Overall Size	Adhesive Size	Oval Aperture Size	Drapes per Box	Boxes per Case
80 cm x 130 cm	10 cm x 12.5 cm	5.1 cm x 7.4 cm	10	4

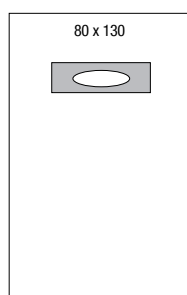

1033 Medium Drape with Wide Adhesive Aperture

Overall Size	Adhesive Size	Oval Aperture Size	Drapes per Box	Boxes per Case
80 cm x 130 cm	23 cm x 11.5 cm	15 cm x 6 cm	10	4

Clear Plastic Drapes

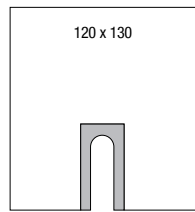

1015 U-Drape

Overall Size	Drapes per Box	Boxes per Case
120 cm x 130 cm	10	4

- U-Slot Aperture with Adhesive

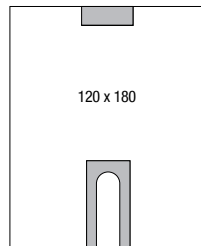

1019 Long U-Drape

Overall Size	Drapes per Box	Boxes per Case
120 cm x 180 cm	10	4

- U-Slot Aperture with Adhesive
- Adhesive Patch

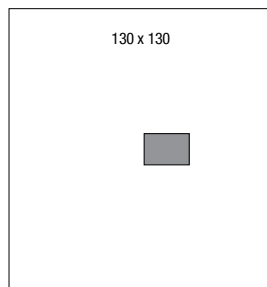

1060 Medium Drape with Incise Film

Overall Size	3M™ Steri-Drape™ Incise Area	Drapes per Box	Boxes per Case
130 cm x 130 cm	10 cm x 12.5 cm	10	4

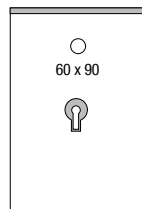

1071 Urological Sheet

Overall Size	Aperture Size	Drapes per Box	Boxes per Case
60 cm x 90 cm	5 cm	10	4

- Neoprene Finger Cot with Adhesive
- Adhesive Strip

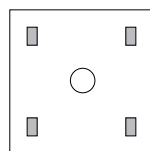

Wound Edge Protector

	Overall Size	Ring Diameter	Drapes per Box	Boxes per Case
1073	23 cm x 11.5 cm	15 cm x 6 cm	10	4
1074	90 cm x 90 cm	12.5 cm	10	4
1075	90 cm x 90 cm	17.5 cm	10	4
1076	90 cm x 90 cm	22.5 cm	10	4
1077	90 cm x 90 cm	9.5 cm	10	4

- 4 Adhesive Patches
- 1 Flexible Ring

KEY	Repellent Fabric	Blue Polyethylene Film	Clear Polyethylene Film	Absorbent Impervious Fabric
	Extra Absorbent Material	3M™ Ioban™ Antimicrobial Incise Film	3M™ Steri-Drape™ Incise Film	Clear Elastomeric Film
	Adhesive Area	Blue Elastomeric Film		

Dimensions are approximate

Accessories



54

9096 Arm Cover

Overall Size	Items per Box	Boxes per Case
54 cm	100	1

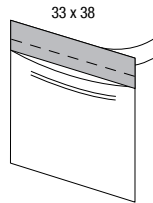

33 x 38

9097 Instrument Pouch (L)

Overall Size	Drapes per Box	Boxes per Case
33 cm x 38 cm	100	2



Stockinette

	Overall Size	Drapes per Box	Boxes per Case
9109	20 cm x 76 cm	20	1
9110	30 cm x 122 cm	20	1

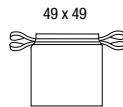

49 x 49

1003 Isolation Bag

Overall Size	Drapes per Box	Boxes per Case
49 cm x 49 cm	10	4

- Drawstring Closure
- Clear Plastic

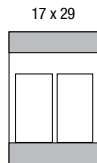

17 x 29

1018 Instrument Pouch

Overall Size	Drapes per Box	Boxes per Case
17 cm x 29 cm	10	4

- 2 Adhesive Strips
- 2 Compartments

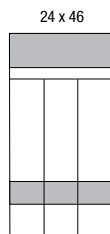

24 x 46

1018L Instrument Pouch

Overall Size	Drapes per Box	Boxes per Case
24 cm x 46 cm	10	4

- 2 Adhesive Strips
- 3 Compartments

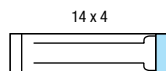

14 x 4

1115 Tube Organiser

Overall Size	Units per Box	Boxes per Case
14 cm x 4 cm	100	4

Fluid Collection Pouches

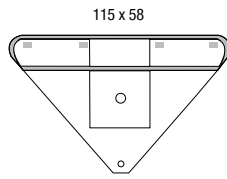

1007 Arthroscopy Fluid Collection Pouch

Overall Size	Drapes per Box	Boxes per Case
115 cm x 58 cm	10	4

- Adhesive Strips
- 1 Exit Port

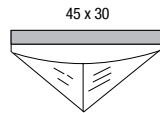

1027 Irrigation Pouch

Overall Size	Drapes per Box	Boxes per Case
45 cm x 30 cm	10	4

- Adhesive Strip

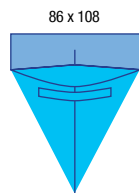

1084 Under Buttocks Drape with Pouch

Overall Size	Drapes per Box	Boxes per Case
86 cm x 108 cm	30	4

- Fluid Collection Pouch

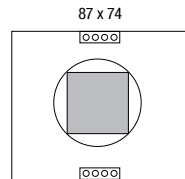

2057 Incise Pouch

Overall Size	3M™ Steri-Drape™ Incise Area	Drapes per Box	Boxes per Case
87 cm x 74 cm	30 cm x 30 cm	10	4

- 360-Degree Fluid Collection Pouch
- Tube Organisers

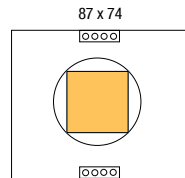

6657 Pouch with 3M™ Ioban™ 2 Incise Film

Overall Size	Ioban 2 incise area	Drapes per Box	Boxes per Case
87 cm x 74 cm	30 cm x 30 cm	10	4

- 360-Degree Fluid Collection Pouch
- Tube Organisers

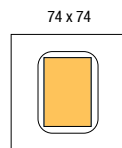

6658 Large Pouch with 3M™ Ioban™ 2 Incise Film

Overall Size	Ioban 2 incise area	Drapes per Box	Boxes per Case
74 cm x 74 cm	33 cm x 43 cm	5	4

- Fluid Collection Pouch

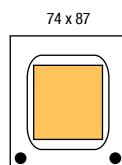

6659 Extra Large Pouch with 3M™ Ioban™ 2 Incise Film

Overall Size	Ioban 2 incise area	Drapes per Box	Boxes per Case
74 cm x 87 cm	42 cm x 52 cm	5	4

- 2 Exit Ports

KEY	Repellent Fabric	Blue Polyethylene Film	Clear Polyethylene Film	Absorbent Impervious Fabric
	Extra Absorbent Material	3M™ Ioban™ Antimicrobial Incise Film	3M™ Steri-Drape™ Incise Film	Clear Elastomeric Film
	Adhesive Area	Blue Elastomeric Film		

Dimensions are approximate

Fluid Collection Pouches

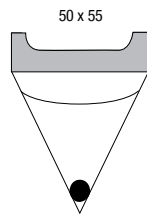

1016 Irrigation Pouch

Overall Size	Drapes per Box	Boxes per Case
50 cm x 55 cm	10	4

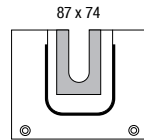

1067 U-Pouch

Overall Size	Drapes per Box	Boxes per Case
87 cm x 74 cm	5	4

- U-Slot Aperture with Adhesive
- 2 Exit Ports

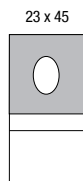

1072 Aperture Pouch Drape

Overall Size	Adhesive Size	Oval Aperture Size	Drapes per Box	Boxes per Case
23 cm x 45 cm	23 cm x 25 cm	11 cm x 8.5 cm	10	4

- Pouch Size: 15.5cm x 23cm

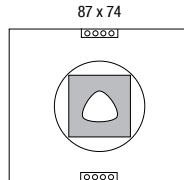

2058 Aperture Pouch

Overall Size	Fenestrated Incise Area	Drapes per Box	Boxes per Case
87 cm x 74 cm	30 cm x 30 cm	10	4

- 360-Degree Fluid Collection Pouch
- Tube Organisers

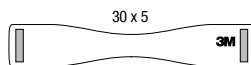

8010 Patient Face Protector

Overall Size	Items per Box
30 cm x 5 cm	100

- Only available as Non Sterile.

Equipment Cover Drapes

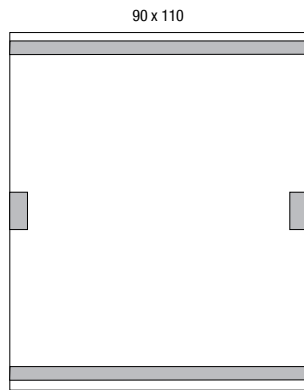

1012 Fluoroscope Drape

Overall Size	Drapes per Box	Boxes per Case
90 cm x 110 cm	10	4

- 2 Adhesive Strips
- 2 Adhesive Patches

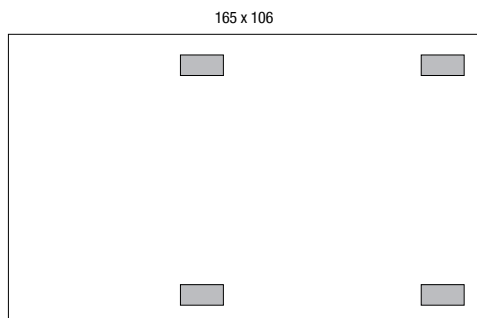

1013 X-ray Image Intensifier Drape

Overall Size	Drapes per Box	Boxes per Case
165 cm x 106 cm	10	4

- 4 Adhesive Patches

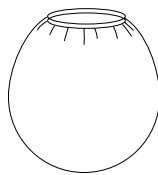

Banded Bag

	Overall Size	Drapes per Box	Boxes per Case
1096	50 cm	25	1
1097	66 cm	25	1
1098	100 cm	25	1
1099	127 cm	25	1

- Latex-free Elasticated Opening

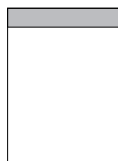

X-ray Cassette Drape

	Overall Size	Drapes per Box	Boxes per Case
1008	36 cm x 49 cm	25	1
1009	56 cm x 59 cm	25	1
1011	57.5 cm x 62.5 cm	25	2

- Adhesive Closure

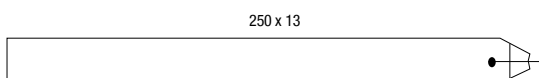

1100E Camera/Laser Drape

Overall Size	Drapes per Box	Boxes per Case
250 cm x 13 cm	50	1

- With Elastoflex™ KG Semi-Opaque Fenestration

KEY	Repellent Fabric	Blue Polyethylene Film	Clear Polyethylene Film	Absorbent Impervious Fabric
	Extra Absorbent Material	3M™ Ioban™ Antimicrobial Incise Film	3M™ Steri-Drape™ Incise Film	Clear Elastomeric Film
	Adhesive Area	Blue Elastomeric Film		

Dimensions are approximate

Equipment Cover Drapes

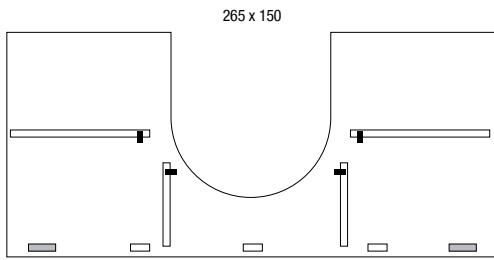

1101 One Piece C-Arm Drape

Overall Size	Drapes per Box	Boxes per Case
265 cm x 150 cm	10	2

- Hook and Loop Fasteners, Poly Straps and Adhesive Strips

Incise Drapes

General Surgery Drapes / Packs

Orthopaedic Drapes / Packs

Cardiovascular and Cardiac Catheterisation Drapes / Packs

Obstetrics and Gynaecology Drapes / Packs

Urology Drapes / Packs

Ophthalmic Drapes / Packs

Head and Neck Drapes / Packs

Neurosurgery Drapes / Packs

Other Drapes and Accessories

Single Use Gowns – Standard and Reinforced

Custom Packs and Procedure Trays

Cross Reference by Product Number

Cross Reference by Product Name



Single Use Gowns – Standard and Reinforced

3M™ High Protection Gown – Regular, Standard and Reinforced

High Protection without compromising on Comfort.

Protection

- Fluid repellent.
- Alcohol repellent.
- Good strength characteristics.
- Low linting.
- Ultrasonic bonded seams.
- Overlapping back.
- For medium (Standard) to high (Reinforced) fluid exposure.
- Generous length.**

Comfort

- Lightweight and comfortable.
 - Roomy design.
 - Adjustable neckline.
 - Regular, Standard and Reinforced designs
- EN 13795 Standard Performance (Regular, Standard) and High Performance (Reinforced)

SMMS non-woven fabric

Outer layer

Spunbond: strength, fluid + alcohol repellent

2 Middle layers

Meltblown: fluid control, bacterial barrier

Inner layer

Spunbond: strength, fluid repellent



3M™ Comfort Gown – Standard and Reinforced

High Comfort without compromising on Protection.

Protection

- Fluid repellent.
- Alcohol repellent.
- Excellent strength characteristics.
- Tape covered seams.
- Overlapping back.
- For low (Standard) to high (Reinforced) fluid exposure.
- Generous length.

Comfort

- Extremely lightweight and comfortable.
- Soft material.
- Roomy design.
- Adjustable neckline.
- Standard and Reinforced designs.

EN 13795 Standard Performance

Spunlace non-woven fabric

2 layers

Spunlace: fluid + alcohol repellent, soft, strong



3M™ Basic Gown – Standard

Protection and comfort for surgeries with expected low fluid levels.

Protection

- Fluid repellent.
- Good strength characteristics.
- Low linting.
- Ultrasonic bonded seams.
- Overlapping back.
- For lower fluid procedures.

Comfort

- Lightweight and comfortable.
- Roomy design.
- Adjustable neckline.
- Standard design.*

EN 13795 Standard Performance

SMMS non-woven fabric

Outer layer

Spunbond: strength, fluid repellent

2 Middle layers

Meltblown: fluid control, bacterial barrier

Inner layer

Spunbond: strength, fluid repellent



* For high fluid procedures please use High Protection Reinforced Gown.

** Only for Standard and Reinforced Designs.

3M™ High Protection Disposable Surgical Gowns – Regular, Standard and Reinforced

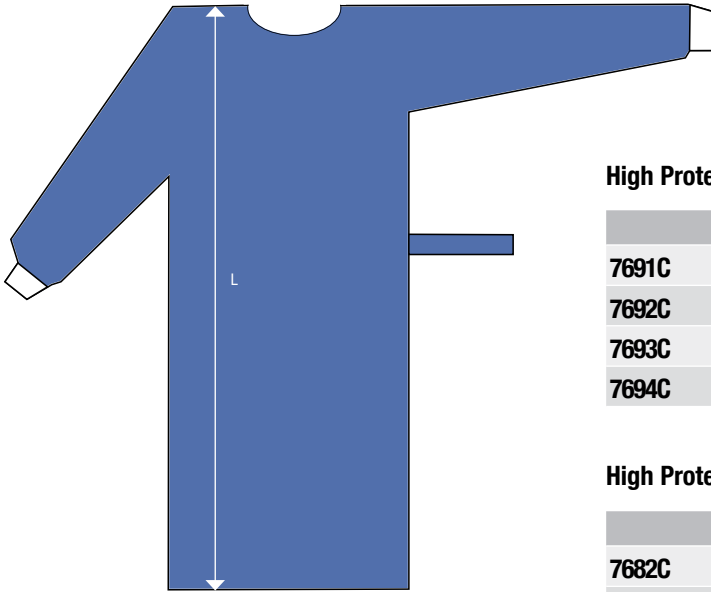

High Protection Disposable Surgical Gown – Standard

	Size	Length (L)	Boxes per Case	Items per Box
7691C	Medium	129	1	28
7692C	Large	142	1	26
7693C	XLarge	148	1	24
7694C	XXLarge	156	1	22

High Protection Disposable Surgical Gown – Regular

	Size	Length (L)	Boxes per Case	Items per Box
7682C	Large	127	1	30
7683C	XLarge	133	1	26
7684C	XXLarge	141	1	24

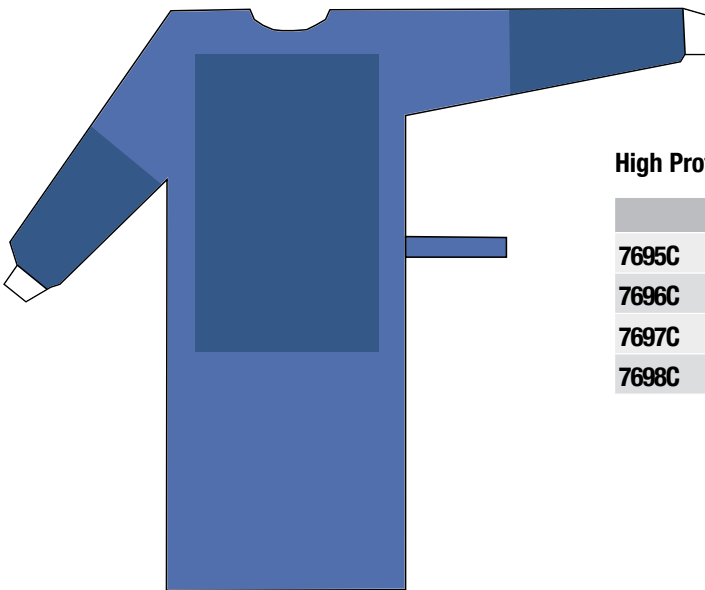

High Protection Disposable Surgical Gown – Reinforced

	Size	Length (L)	Boxes per Case	Items per Box
7695C	Medium	129	1	22
7696C	Large	142	1	20
7697C	XLarge	148	1	18
7698C	XXLarge	156	1	16

Dimensions are approximate

3M™ Comfort Surgical Gowns – Standard and Reinforced

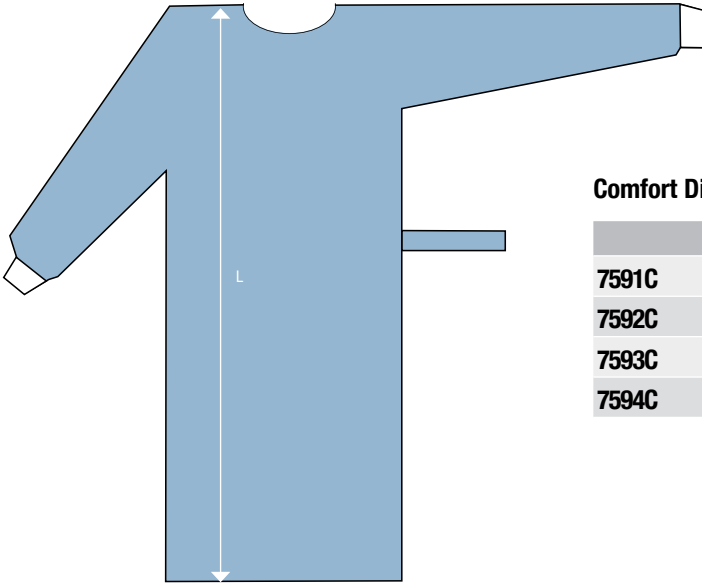

Comfort Disposable Surgical Gown – Standard

	Size	Length (L)	Boxes per Case	Items per Box
7591C	Medium	129	1	22
7592C	Large	142	1	20
7593C	XLarge	148	1	18
7594C	XXLarge	156	1	16

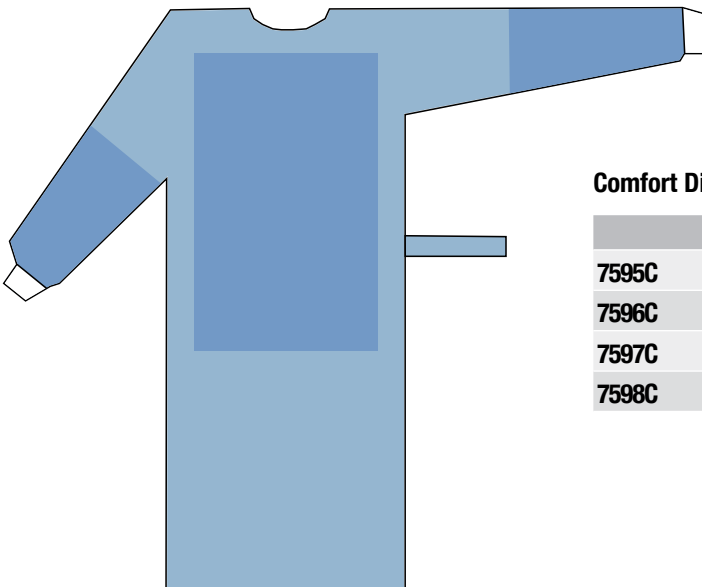

Comfort Disposable Surgical Gown – Reinforced

	Size	Length (L)	Boxes per Case	Items per Box
7595C	Medium	129	1	18
7596C	Large	142	1	18
7597C	XLarge	148	1	16
7598C	XXLarge	156	1	16

Dimensions are approximate

3M™ Basic Surgical Gowns – Standard and Standard T

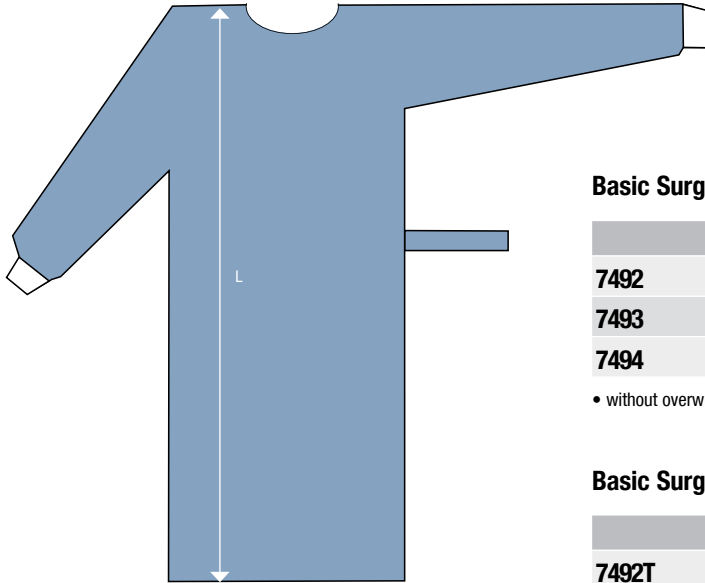

Basic Surgical Gown – Standard

	Size	Length (L)	Boxes per Case	Items per Box
7492	Large	127	1	30
7493	XLarge	133	1	26
7494	XXLarge	141	1	24

- without overwrap and handtowel

Basic Surgical Gown – Standard T

	Size	Length (L)	Boxes per Case	Items per Box
7492T	Large	127	1	26
7493T	XLarge	133	1	24
7494T	XXLarge	141	1	22

- incl. overwrap and 2 handtowels

Incise Drapes

General Surgery Drapes / Packs

Orthopaedic Drapes / Packs

Cardiovascular and Cardiac Catheterisation Drapes / Packs

Obstetrics and Gynaecology Drapes / Packs

Urology Drapes / Packs

Ophthalmic Drapes / Packs

Head and Neck Drapes / Packs

Neurosurgery Drapes / Packs

Other Drapes and Accessories

Single Use Gowns – Standard and Reinforced

Custom Packs and Procedure Trays

Cross Reference by Product Number

Cross Reference by Product Name



Custom Packs and Procedure Trays

3M™ Custom Procedure Trays – Reliable, Flexible, Cost effective

Whatever your requirements, 3M Health Care can design a procedure tray that meets your needs. We can access over 20,000 components from other leading health care manufacturers, and you have our assurance that every pack will still conform to our high standards of quality, reliability and performance.

Please contact our Customer Service Team for further details of how our customised service can help you.

In addition to customised procedure trays, drape packs are also available. Please see the relevant procedure sections for details.

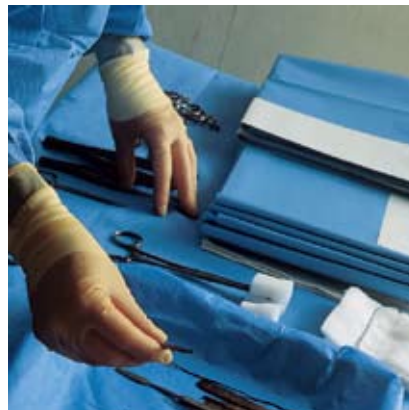

Incise Drapes

General Surgery Drapes / Packs

Orthopaedic Drapes / Packs

Cardiovascular and Cardiac Catheterisation Drapes / Packs

Obstetrics and Gynaecology Drapes / Packs

Urology Drapes / Packs

Ophthalmic Drapes / Packs

Head and Neck Drapes / Packs

Neurosurgery Drapes / Packs

Other Drapes and Accessories

Single Use Gowns – Standard and Reinforced

Custom Packs and Procedure Trays

Cross Reference by Product Number

Cross Reference by Product Name

Cross Reference by Product Number

Incise Drapes		Page	Incise Drapes		Page
1035	Incise Drape	14	2051	Incise Drape	13
1037	Incise Drape	14	6635	Antimicrobial Incise Drape	11
1040	Incise Drape	14	6640	Antimicrobial Incise Drape	11
1050	Incise Drape	14	6648	Antimicrobial Incise Drape	11
1051	Incise Drape	14	6650	Antimicrobial Incise Drape	11
2035	Incise Drape	13	6651	Antimicrobial Incise Drape	11
2037	Incise Drape	13	6640EZ	Antimicrobial Incise Drape	12
2040	Incise Drape	13	6648EZ	Antimicrobial Incise Drape	12
2045	Incise Drape	13	6650EZ	Antimicrobial Incise Drape	12
2050	Incise Drape	13	6651EZ	Antimicrobial Incise Drape	12
			6661EZ	Antimicrobial Incise Drape	12

Speciality Packs/Drapes		Page	Speciality Packs/Drapes		Page
1000	Small Towel Drape	74, 80	1065B	Large Ophthalmic Sheet with Aperture and Pouches	65
1003	Isolation Bag	23, 82	1067	U-Pouch	35, 84
1007	Arthroscopy Fluid Collection Pouch	34, 83	1071	Urological Sheet	58, 81
1008	X-ray Cassette Drape	85	1072	Aperture Pouch Drape	48, 58, 84
1009	X-ray Cassette Drape	85	1073	Wound Edge Protector	23, 81
1010	Large Towel Drape	74, 80	1074	Wound Edge Protector	23, 81
1011	X-ray Cassette Drape	85	1075	Wound Edge Protector	23, 81
1012	Fluoroscope Drape	85	1076	Wound Edge Protector	23, 81
1013	X-ray Image Intensifier Drape	85	1077	Wound Edge Protector	23, 81
1014	Patient Isolation Drape	34	1078	Perineal Drape with Pouch	48, 58
1015	U-Drape	34, 81	1079	Gynaecological Drape	48, 58
1016	Irrigation Pouch	23, 34, 47, 57, 74, 84	1079P	Gynaecological Pack	48, 58
1017	Isolation Drape with Incise Film and Pouch	34	1080	Gynaecological Drape with 1072 Pouch	48, 59
1017P001	Patient Isolation Pack	34	1080PD	Gynaecological Pack with 1072 Pouch	48, 59
1018	Instrument Pouch	82	1081	TUR/Urological Drape	59
1018L	Instrument Pouch – Long	82	1081P	TUR Pack	59
1019	Long U-Drape	35, 81	1082	TVT/TOT Drape	49, 59
1020	Small Drape with Adhesive Aperture	63, 80	1083NS	Perineal Leg Sheet	41
1021	Small Drape with Incise Film	63, 80	1084	Under Buttocks Drape with Pouch	24, 49, 83
1022	Refractive Drape	63	1084P	Delivery Pack	49
1023	Small Drape with Incise Film and Pouch	63	1090	Femoral Angiography Drape	41
1024	Small Drape with Adhesive Aperture and Pouch	63	1092	Minor Procedure Drape	24
1027	Irrigation Pouch	83	1094	Arthroscopy Sheet with Pouch	35
1030	Medium Drape with Adhesive Aperture	64, 80	1096	Banded Bag	85
1031	Laparoscopic Drape – Supine Position	23, 47, 57	1097	Banded Bag	85
1032	Laparoscopic Drape – Lithotomy Position	23, 47, 57	1098	Banded Bag	85
1032P	Laparoscopic Drape Pack / Lithotomy Position	23, 47, 57	1099	Banded Bag	85
1033	Medium Drape with Wide Adhesive Aperture	64, 80	1100E	Camera/Laser Drape	85
1034	CVC Drape	24, 40	1101	One Piece C-Arm Drape	86
1055B	Large Ophthalmic Drape with Incise Film and Pouches	65	1115	Tube Organiser	24, 35, 82
1060	Medium Drape with Incise Film	64, 81	1190NS	Angiography Drape	41
1061	Medium Drape with Incise Film and Pouch	64	1191	Femoral Angiography Drape	41
1062	Ophthalmic Drape with Incise Film and Pouch	65	1191P	Angiography Pack	41
1062P001	Ophthalmology Pack	65	1194	Arthroscopy Sheet with Pouch	36
1064	Ophthalmic Sheet with Aperture and Pouches	66	1194P	Arthroscopy Pack	36

Specialty Packs/Drapes		Page	Specialty Packs/Drapes		Page
2057	Incise Pouch	24, 49, 83	9040	Leggings (Pair)	20, 46, 56, 78
2058	Aperture Pouch	24, 49, 84	9040L	Leggings Long (pair)	20, 56, 78, 46
2065	Abdomino-Perineal Drape – Lithotomy Position	25, 50, 60	9041	Leggings	78
2065P	Abdomino-Perineal Draping Pack	25, 50, 60	9042	Leggings	78
6617	Isolation Drape with 3M™ Ioban™ 2 Film and Pouch	36	9043	Adhesive Split Sheet	31, 77
6617P001	Patient Isolation Pack with 3M™ Ioban™ 2 Film and Pouch	36	9044	Adhesive Split Sheet	31, 77
6619	Large Isolation Drape with 3M™ Ioban™ 2 Film and Pouch	36	9045	Adhesive Split Sheet	31, 77
6657	Pouch with 3M™ Ioban™ 2 Incise Film	25, 50, 83	9046	Bilateral Split Sheet	39, 77
6658	Large Pouch with 3M™ Ioban™ 2 Incise Film	25, 50, 83	9047	Neuro Split Sheet with Pouch	73
6659	Extra Large Pouch with 3M™ Ioban™ 2 Incise Film	25, 50, 83	9048	Split Sheet	73, 77
6665	3M™ Ioban™ 2 Abdomino-Perineal Drape – Lithotomy Position	26, 51, 60	9050	Adhesive Aperture Drape	20, 56
6665P001	Abdomino-Perineal Draping Pack	26, 51, 60	9050P	Adhesive Aperture Pack	20
6677	Cardiovascular Sheet with 3M™ Ioban™ 2 Incise Film	40	9051	Thyroid Drape	20, 70
6677P	Cardiovascular Pack with 3M™ Ioban™ 2 Incise Film	40	9052	Hand Drape	20, 31
6681	3M™ Ioban™ 2 Cardiovascular Drape	40	9053	Extremity Drape	31
6682	Steri-Drape Cardio/Cest Drape with 3M™ Ioban™ 2 Incise Film	40	9053P	Basic Extremity Pack	31
6687	Craniotomy Drape with 3M™ Ioban™ 2 Incise Film	74	9054	Foot/Hand Drape	21, 32
6687P	Craniotomy Pack with 3M™ Ioban™ 2 Incise Film	74	9054P	Foot/Hand Pack	21, 32
6697	Caesarean Section Sheet with 3M™ Ioban™ 2 Incise Pouch	51	9055	One-Piece Hip Drape with Side Pouches	32
6697P001	Caesarean Section Pack with 3M™ Ioban™ 2 Incise Pouch	51	9055P	One-Piece Hip Pack	32
7964	Caesarean Section Drape with 3M™ Steri-Drape™ 2 Incise Pouch-Lithotomy Position	52	9056	Bilateral Foot Drape	32
7965	Caesarean Section Drape with 3M™ Steri-Drape™ 2 Incise Pouch	52	9057	Extremity Drape	32
7965P	Caesarean Section Pack with 3M™ Steri-Drape™ 2 Incise Pouch	52	9058	Bilateral Knee Drape	32
7966	Caesarean Section Sheet with Aperture Pouch	52	9062	Laparotomy Drape (Transverse)	21
8010	Patient Face Protector	84	9063	Laparotomy Drape	21, 33
9000	Basic Surgical Pack	17, 29, 45, 55	9066	Under Buttock Drape with Cuff	22, 46, 56
9000L	Basic Surgical Pack	17	9067	Non Adhesive Drape Sheet/Instrument Table Cover	79
9001	Paediatric Pack	17	9069	Non Adhesive Drape Sheet/Instrument Table Cover	79
9002	Orthopaedic Surgical Pack without Mayo	29	9070	Turban Drape Sheet	70
9003	Cystoscopy Surgical Pack	45, 55	9071	Non Adhesive Drape Sheet	79
9004	Extremity Surgical Pack	29	9072	Drape Sheet/Instrument Table Cover	79
9005	TUR/CYSTO Pack	55	9074	Back Table Cover	79
9007	ENT Surgical Pack	17, 69, 73	9075	Non Adhesive Drape Sheet/Instrument Table Cover	79
9008	Head and Neck Pack	18, 69	9077/9077R	Non Adhesive Drape Sheet/Instrument Table Cover	79
9009	Basic Head and Neck Pack	18, 69	9079	Non Adhesive Drape Sheet/Instrument Table Cover	79
9010	Basic Surgical Pack without Mayo	18, 30, 45, 55	9084	Adhesive Towel Drape	79
9012	Orthopaedic Surgical Pack	30	9085	Adhesive Towel Drape	79
9012L	Orthopaedic Surgical Pack	30	9085P	Surgical Towel Pack	22
9014	Extremity Surgical Pack	30	9086	Adhesive Towel Drape	79
9015	Hand Pack	19, 31	9087	Adhesive Drape Sheet	79
9018	Surgical Split Sheet Pack	19, 39	9088	Adhesive Drape Sheet	79
9019	Oral Pack	19, 66, 70	9089	Adhesive Drape Sheet	79
9023	Perineal Aperture Drape	45, 56	9090	Adhesive Drape Sheet	79
9026	Aperture Drape	77	9095	Absorbent Pad	79
9027	Adjustable Aperture Drape	19, 77	9096	Arm Cover	82
9027L	Adjustable Aperture Drape (Long)	19, 77	9097	Instrument Pouch (L)	82
9028	Adhesive Aperture Drape	78	9099	Operation Tape	79
9029	Adhesive Aperture Drape	77	9100	General Pack	18, 33, 39, 46, 70
9030	Adhesive Aperture Drape	78	9105	Lithotomy Pack – Under Buttock	22, 46, 56
9031	Adhesive Aperture Drape	78	9106	Lithotomy Pack – with Pouch	22, 47, 57
9035	Mayo Stand Cover	78	9109	Stockinette	33, 82
9039E	Reinforced Mayo Stand Cover	78	9110	Stockinette	33, 82
			9196	Shoulder Split Sheet with Pouch	33
			9196P	Shoulder Athroscopy Pack	33

Cross Reference by Product Number

Disposable Surgical Gowns		Size	Page	Disposable Surgical Gowns		Size	Page
7691C	High Protection Disposable Surgical Gown – Standard	M	89	7591C	Comfort Disposable Surgical Gown – Standard	M	90
7692C	High Protection Disposable Surgical Gown – Standard	L	89	7592C	Comfort Disposable Surgical Gown – Standard	L	90
7693C	High Protection Disposable Surgical Gown – Standard	XL	89	7593C	Comfort Disposable Surgical Gown – Standard	XL	90
7694C	High Protection Disposable Surgical Gown – Standard	XXL	89	7594C	Comfort Disposable Surgical Gown – Standard	XXL	90
7682C	High Protection Disposable Surgical Gown – Regular	L	89	7595C	Comfort Disposable Surgical Gown – Reinforced	M	90
7683C	High Protection Disposable Surgical Gown – Regular	XL	89	7596C	Comfort Disposable Surgical Gown – Reinforced	L	90
7684C	High Protection Disposable Surgical Gown – Regular	XXL	89	7597C	Comfort Disposable Surgical Gown – Reinforced	XL	90
7695C	High Protection Disposable Surgical Gown – Reinforced	M	89	7598C	Comfort Disposable Surgical Gown – Reinforced	XXL	90
7696C	High Protection Disposable Surgical Gown – Reinforced	L	89				
7697C	High Protection Disposable Surgical Gown – Reinforced	XL	89	7492	Basic Surgical Gown – Standard	L	91
7698C	High Protection Disposable Surgical Gown – Reinforced	XXL	89	7493	Basic Surgical Gown – Standard	XL	91
				7494	Basic Surgical Gown – Standard	XXL	91
				7492T	Basic Surgical Gown – Standard T	L	91
				7493	Basic Surgical Gown – Standard T	XL	91
				7494	Basic Surgical Gown – Standard T	XXL	91

Custom Packs and Procedure Trays

Page

– Custom Packs and Procedure Trays

94

Incise Drapes

General Surgery Drapes / Packs

Orthopaedic Drapes / Packs

Cardiovascular and Cardiac Catheterisation Drapes / Packs

Obstetrics and Gynaecology Drapes / Packs

Urology Drapes / Packs

Ophthalmic Drapes / Packs

Head and Neck Drapes / Packs

Neurosurgery Drapes / Packs

Other Drapes and Accessories

Single Use Gowns – Standard and Reinforced

Custom Packs and Procedure Trays

Cross Reference by Product Number

Cross Reference by Product Name

Cross Reference by Product Name

3M™ Incise Drapes		
Productname	Catalog Number	Category
Antimicrobial Incise Drapes	6635, 6640, 6648, 6650, 6651 6640EZ, 6648EZ, 6650EZ, 6651EZ, 6661EZ	3M™ Ioban™ 2 Antimicrobial Incise Drapes, 3M™ Ioban™ EZ Antimicrobial Incise Drapes
Incise Drapes	1035, 1037, 1040, 1050, 1051 2035, 2037, 2040, 2045, 2050, 2051	3M™ Steri-Drape™ Incise Drapes 3M™ Steri-Drape™ 2 Incise Drapes

3M™ Surgical Packs		
Abdomino-Perineal Draping Packs	2065P, 6665P001	General Surgery
Angiography Packs	1191P	Cardiovascular/Cardiac Catheterisation
Arthroscopy Packs	1194P, 9196P	Orthopaedic
Cardio-Vascular Packs	6677, 6677P, 6681, 6682, 9018	Cardiovascular/Cardiac Catheterisation
Caesarean Section Packs	6697P001, 7965P	Obstetrics, Gynaecology
Craniotomy Pack	6687P	Obstetrics, Gynaecology
Cystoscopy Packs	9003	Urology
Delivery Pack	1084P	Neurosurgery
ENT Packs	9007, 9008	Head and Neck
Extremity Packs	9004, 9014, 9053P	Orthopaedic
General Surgery Packs	9000, 9000L, 9010, 9018, 9050P, 9085P, 9100	General Surgery
Gynaecological Packs	1079P, 1080P	Obstetrics, Gynaecology
Hand Packs	9015	General Surgery
Hand/Foot Packs	9054P	Orthopaedic
Head and Neck Packs	9007, 9008, 9009	Head and Neck
Hip Packs	9002, 9012, 9012L, 9055P	Orthopaedic
Laparoscopic Packs	1032P	General Surgery
Lithotomy Pack	9105, 9106	General Surgery
Oral Pack	9019	Head and Neck
Ophthalmic Packs	1062P001	Ophthalmic
Orthopaedic Packs	9002, 9012, 9012L	Orthopaedic
Paediatric Packs	9001	General Surgery
Towel Packs	9085P	General Surgery
TUR Packs	1081PD, 9005	Urology
Vertical Isolation Packs	1017P001, 6617P001	Orthopaedic

3M™ Surgical Drapes		
Abdomino-Perineal Drapes – Lithotomy Position	2065, 6665	General Surgery
Absorbent Pad	9095	Other Drapes and Accessories
Angiography Drape	1190NS	Cardiovascular/Cardiac Catheterisation
Aperture Drapes (Adhesive)	1020, 1024, 1030, 1033 1092 9027, 9028, 9029, 9030, 9031, 9050	Ophthalmic General Surgery Other Drapes and Accessories
Aperture Drapes	9026	Other Drapes and Accessories
Arthroscopy Drapes	1094, 1194	Orthopaedic
Caesarean Section Drapes	6697, 7964, 7965, 7966	Obstetrics, Gynaecology
Cardiovascular Drapes	6677, 6681, 6682	Cardiovascular/Cardiac Catheterisation

3M™ Surgical Drapes

Productname	Catalog Number	Category
Cardiovascular Perineal Leg Sheet	1083NS (only for CP/CPT)	Cardiovascular/Cardiac Catheterisation
Craniotomy Drape	6687	Neurosurgery
CVC Drape	1034	Cardiovascular/Cardiac Catheterisation
Drapes Sheets (Adhesive)	9087, 9088, 9089, 9090	Other Drapes and Accessories
Drapes Sheet/Instrument Table Cover	9067, 9069E, 9071, 9072, 9074, 9075, 9077, 9077R, 9079	Other Drapes and Accessories
Drapes with Incise Film (Plastic)	1021, 1060	Ophthalmic
Drapes with Incise Film and Pouch (Plastic)	1023, 1061	Ophthalmic
Extremity Drapes	9053, 9056, 9057, 9058	Orthopaedic
Femoral Angiography Drapes	1191, 1090	Cardiovascular/Cardiac Catheterisation
Foot/Hand Drape	9054	Orthopaedic
Gynaecological Drapes	1079, 1080, 1082	Obstetrics, Gynaecology
Hand Drape	9052	Orthopaedic
Hip Drape	9055	Orthopaedic
Laparotomy/Laparoscopy Drapes	9062, 9063, 1031, 1032	General Surgery
Mayo Stand Cover	9035, 9039E	Other Drapes and Accessories
Neuro Split Sheet with Pouch	9047	Neurosurgery
Ophthalmic Drapes	1020, 1021, 1022, 1023, 1024, 1030, 1033, 1055B 1060, 1061, 1062, 1064, 1065B	Ophthalmic
Perineal Drape Sheet	1078, 9023	Urology
Refractive Drape	1022	Ophthalmic
Shoulder Split Sheet with Pouch	9196	Orthopaedic
Split Sheets (Adhesive)	9043, 9044, 9045, 9048	Other Drapes and Accessories
Split Sheet (Plastic)	1015, 1019	Other Drapes and Accessories
Split Sheet Bilateral	9046	Cardiovascular/Cardiac Catheterisation
Thyroid Drape	9051	General Surgery
Towel Drapes (Adhesive)	1000, 1010, 9084, 9085, 9086	Other Drapes and Accessories
TUR/Urological Drape	1081	Urology
Turban Drape Sheet	9070	Head and Neck
Under Bullock Drape	9066	General Surgery
Vertical Isolation Drapes	1014, 1017, 6617, 6619	Orthopaedic

Equipment Cover

Banded Bag	1096, 1097, 1098, 1099	Other Drapes and Accessories
Camera/Laser Drape	1100E	Other Drapes and Accessories
Fluoroscope Drape	1012	Other Drapes and Accessories
One Piece C-Arm Drape	1101	Other Drapes and Accessories

Cross Reference by Product Name

Equipment Cover		
Productname	Catalog Number	Category
X-Ray Casste Drapes	1008, 1009, 1011	Other Drapes and Accessories
X-Ray Image Intensifier Drape	1013	Other Drapes and Accessories
Accessories & Fluid Collection Pouches		
Aperture Pouch	1072, 2058	Other Drapes and Accessories
Arm Cover	9096	Other Drapes and Accessories
Arthroscopy Fluid Collection Pouch	1007	Other Drapes and Accessories
Incise Pouch with 3M™ Steri-Drape™ 2 Incise Film	2057	Other Drapes and Accessories
Incise Pouch with 3M™ Ioban™ 2 Incise Film	6657, 6658, 6659	Other Drapes and Accessories
Instrument Pouch	1018, 1018L, 9097	Other Drapes and Accessories
Irrigation Pouch	1016, 1027	Other Drapes and Accessories
Isolation Bag	1003	Other Drapes and Accessories
Leggings	9040, 9041, 9042	Other Drapes and Accessories
Operation Tape	9099	Other Drapes and Accessories
Patient Face Protector	8010	Other Drapes and Accessories
Stockinette	9109, 9110	Other Drapes and Accessories
Tube Organizer	1115	Other Drapes and Accessories
Under Buttocks Drape with Pouch	1084	Other Drapes and Accessories
U-pouch	1067	Other Drapes and Accessories
Urological Sheet	1071	Other Drapes and Accessories
Wound Edge Protector	1073, 1074, 1075, 1076, 1077	Other Drapes and Accessories
3M™ Surgical Gowns		
Productname	Catalog Number	Category
High Protection Disposable Surgical Gown – Reinforced	7695C, 7696C, 7697C, 7698C	Single Use Gowns – Standard and Reinforced
High Protection Disposable Surgical Gown – Standard	7691C, 7692C, 7693C, 7694C,	Single Use Gowns – Standard and Reinforced
High Protection Disposable Surgical Gown – Regular	7682C, 7683C, 7684C	Single Use Gowns – Standard and Reinforced
Comfort Standard Disposable Surgical Gown – Standard	7591C, 7592C, 7593C, 7594C	Single Use Gowns – Standard and Reinforced
Comfort Reinforced Disposable Surgical Gown – Reinforced	7595C, 7596C, 7597C, 7598C	Single Use Gowns – Standard and Reinforced
Basic Disposable Surgical Gown – Standard	7492, 7493, 7494	Single Use Gowns – Standard and Reinforced
Basic Disposable Surgical Gown – StandardT	7492T, 7493T, 7494T	Single Use Gowns – Standard and Reinforced
3M™ CPT – Customer Procedure Tray		
Customer Procedure Tray		3M™ CPT – Customer Procedure Tray

